

TOSHIBA CMOS Linear Integrated Circuit Silicon Monolithic

# TCR5SB15U~TCR5SB50U

## 200-mA CMOS Low-Dropout Regulators (Point Regulators)

The TCR5SB15U to TCR5SB50U are CMOS general-purpose single-output voltage regulators with an on/off control input, featuring low dropout voltage and low quiescent bias current. The TCR5SB15U to TCR5SB50U can be enabled and disabled via the CONTROL pin.

These voltage regulators are available in fixed output voltages between 1.5 V and 5.0 V in 0.1-V steps and capable of driving up to 200 mA. They feature overcurrent protection.

The TCR5SB15U to TCR5SB50U are offered in the compact UFV package measuring 2.0 x 2.1 x 0.7 mm and allow the use of small ceramic input and output capacitors. Thus, these devices are ideal for portable applications that require high-density board assembly such as cellular phones.

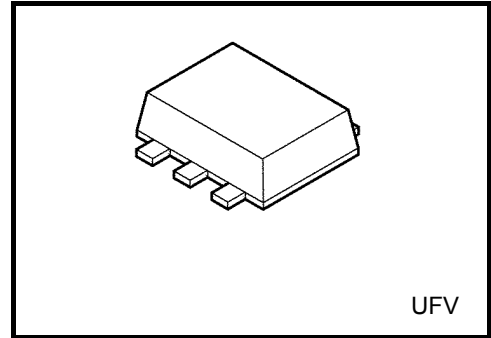

Weight: 0.007 g (typ.)

### Features

- Low quiescent bias current (  $I_B = 40 \mu\text{A}$  (typ.) at  $I_{OUT} = 0 \text{ mA}$  )
- Low stand-by current (  $I_{B(OFF)} = 0.1 \mu\text{A}$  (typ.) at Stand-by mode )
- Low-dropout voltage (  $V_{IN} - V_{OUT} = 85 \text{ mV}$  (typ.) at TCR5SB30U,  $I_{OUT} = 50 \text{ mA}$  )
- High current output (  $I_{OUT} = 200 \text{ mA}$  (max) )
- High ripple rejection ( R.R = 80 dB (typ) at  $I_{OUT} = 10 \text{ mA}$ ,  $f = 1\text{kHz}$  )
- Low output noise voltage (  $V_{NO} = 30 \mu\text{V}_{\text{rms}}$  (typ.) at TCR5SB30U,  $I_{OUT} = 10 \text{ mA}$ ,  $10 \text{ Hz} \leq f \leq 100 \text{ kHz}$  )
- Control voltage can be allowed from -0.3 to 6 V regardless of  $V_{IN}$  voltage.
- Overcurrent protection
- Ceramic capacitors can be used (  $C_{IN} = 0.1\mu\text{F}$ ,  $C_{OUT} = 1.0 \mu\text{F}$  )
- Wide range voltage listing (Please see Output Voltage Accuracy at page 4 for variety of the output voltage )
- Small package, UFV (2.0 mm x 2.1 mm x 0.7 mm)

### Pin Assignment (top view)

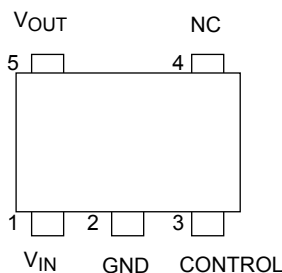

## List of Products Number and Marking

Products No.	Marking	Products No.	Marking
TCR5SB15U	1E5	TCR5SB33U	3E3
TCR5SB16U	1E6	TCR5SB34U	3E4
TCR5SB17U	1E7	TCR5SB35U	3E5
TCR5SB18U	1E8	TCR5SB36U	3E6
TCR5SB19U	1E9	TCR5SB37U	3E7
TCR5SB20U	2E0	TCR5SB38U	3E8
TCR5SB21U	2E1	TCR5SB39U	3E9
TCR5SB22U	2E2	TCR5SB40U	4E0
TCR5SB23U	2E3	TCR5SB41U	4E1
TCR5SB24U	2E4	TCR5SB42U	4E2
TCR5SB25U	2E5	TCR5SB43U	4E3
TCR5SB26U	2E6	TCR5SB44U	4E4
TCR5SB27U	2E7	TCR5SB45U	4E5
TCR5SB28U	2E8	TCR5SB46U	4E6
TCR5SB29U	2E9	TCR5SB47U	4E7
TCR5SB30U	3E0	TCR5SB48U	4E8
TCR5SB31U	3E1	TCR5SB49U	4E9
TCR5SB32U	3E2	TCR5SB50U	5E0

## Marking

Example: TCR5SB30U (3.0 V output)

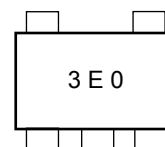

## Absolute Maximum Ratings (Ta = 25°C)

Characteristics	Symbol	Rating	Unit
Input voltage	$V_{IN}$	6	V
Control voltage	$V_{CT}$	-0.3 to 6	V
Output voltage	$V_{OUT}$	-0.3 to $V_{IN} + 0.3$	V
Output current	$I_{OUT}$	200	mA
Power dissipation	$P_D$	450 (Note1)	mW
Operation temperature range	$T_{opr}$	-40 to 85	°C
Junction temperature	$T_j$	150	°C
Storage temperature range	$T_{stg}$	-55 to 150	°C

Note:

Using continuously under heavy loads (e.g. the application of high temperature/current/voltage and the significant change in temperature, etc.) may cause this product to decrease in the reliability significantly even if the operating conditions (i.e. operating temperature/current/voltage, etc.) are within the absolute maximum ratings and the operating ranges.

Please design the appropriate reliability upon reviewing the Toshiba Semiconductor Reliability Handbook ("Handling Precautions"/"Derating Concept and Methods") and individual reliability data (i.e. reliability test report and estimated failure rate, etc).

Note1: Rating at mounting on a board

(Glass epoxy board dimension : 30 mm × 30 mm, Copper pad area : 35 mm<sup>2</sup>)

## Electrical Characteristics

(Unless otherwise specified,

$V_{IN} = V_{OUT} + 1\text{ V}$ ,  $I_{OUT} = 50\text{ mA}$ ,  $C_{IN} = 0.1\text{ }\mu\text{F}$ ,  $C_{OUT} = 1.0\text{ }\mu\text{F}$ ,  $T_j = 25^\circ\text{C}$ )

Characteristics	Symbol	Test Condition	Min	Typ.	Max	Unit	
Output voltage	$V_{OUT}$	Please refer to the Output Voltage Accuracy table					
Line regulation	Reg·line	$V_{OUT} + 0.5\text{ V} \leq V_{IN} \leq 6\text{ V}$ , $I_{OUT} = 1\text{ mA}$	—	3	15	mV	
Load regulation	Reg·load	$1\text{ mA} \leq I_{OUT} \leq 150\text{ mA}$	—	25	75	mV	
Quiescent current	$I_B$	$I_{OUT} = 0\text{ mA}$	—	40	75	$\mu\text{A}$	
Stand-by current	$I_B$ (OFF)	$V_{CT} = 0\text{ V}$	—	0.1	1.0	$\mu\text{A}$	
Output noise voltage	$V_{NO}$	$V_{IN} = V_{OUT} + 1\text{ V}$ , $I_{OUT} = 10\text{ mA}$ , $10\text{ Hz} \leq f \leq 100\text{ kHz}$ , $T_a = 25^\circ\text{C}$	TCR5SB15U to TCR5SB20U	—	25	—	$\mu\text{V}_{\text{rms}}$
			TCR5SB21U to TCR5SB30U	—	30	—	
			TCR5SB31U to TCR5SB36U	—	35	—	
			TCR5SB37U to TCR5SB50U	—	40	—	
Dropout voltage	$V_{IN} - V_{OUT}$	Please refer to the Dropout voltage table.					
Temperature coefficient	$T_{CVO}$	$-40^\circ\text{C} \leq T_{op} \leq 85^\circ\text{C}$	—	100	—	ppm/ $^\circ\text{C}$	
Input voltage	$V_{IN}$	—	TCR5SB15U to TCR5SB16U	$V_{OUT} + 0.33\text{ V}$	—	6.0	V
			TCR5SB17U to TCR5SB18U	$V_{OUT} + 0.31\text{ V}$	—	6.0	
			TCR5SB19U to TCR5SB23U	$V_{OUT} + 0.25\text{ V}$	—	6.0	
			TCR5SB24U to TCR5SB27U	$V_{OUT} + 0.20\text{ V}$	—	6.0	
			TCR5SB28U to TCR5SB50U	$V_{OUT} + 0.19\text{ V}$	—	6.0	
Ripple rejection ratio	R.R.	$V_{IN} = V_{OUT} + 1\text{ V}$ , $I_{OUT} = 10\text{ mA}$ , $f = 1\text{ kHz}$ , $V_{\text{Ripple}} = 500\text{ mV}_{\text{p-p}}$ , $T_a = 25^\circ\text{C}$	—	80	—	dB	
Control voltage (ON)	$V_{CT}$ (ON)	—	1.5	—	6.0	V	
Control voltage (OFF)	$V_{CT}$ (OFF)	—	0	—	0.25	V	
Control current (ON)	$I_{CT}$ (ON)	$V_{CT} = 6.0\text{ V}$	—	—	0.1	$\mu\text{A}$	
Control current (OFF)	$I_{CT}$ (OFF)	$V_{CT} = 0\text{ V}$	—	—	0.1	$\mu\text{A}$	

## Output Voltage Accuracy

( $V_{IN} = V_{OUT} + 1\text{ V}$ ,  $I_{OUT} = 50\text{ mA}$ ,  $C_{IN} = 0.1\text{ }\mu\text{F}$ ,  $C_{OUT} = 1.0\text{ }\mu\text{F}$ ,  $T_j = 25^\circ\text{C}$ )

Product No.	Symbol	Min	Typ.	Max	Unit
TCR5SB15U	V <sub>OUT</sub>	1.47	1.5	1.53	V
TCR5SB16U		1.56	1.6	1.64	
TCR5SB17U		1.66	1.7	1.74	
TCR5SB18U		1.76	1.8	1.84	
TCR5SB19U		1.86	1.9	1.94	
TCR5SB20U		1.96	2.0	2.04	
TCR5SB21U		2.05	2.1	2.15	
TCR5SB22U		2.15	2.2	2.25	
TCR5SB23U		2.25	2.3	2.35	
TCR5SB24U		2.35	2.4	2.45	
TCR5SB25U		2.45	2.5	2.55	
TCR5SB26U		2.54	2.6	2.66	
TCR5SB27U		2.64	2.7	2.76	
TCR5SB28U		2.74	2.8	2.86	
TCR5SB29U		2.84	2.9	2.96	
TCR5SB30U		2.94	3.0	3.06	
TCR5SB31U		3.03	3.1	3.17	
TCR5SB32U		3.13	3.2	3.27	
TCR5SB33U		3.23	3.3	3.37	
TCR5SB34U		3.33	3.4	3.47	
TCR5SB35U		3.43	3.5	3.57	
TCR5SB36U		3.52	3.6	3.68	
TCR5SB37U		3.62	3.7	3.78	
TCR5SB38U		3.72	3.8	3.88	
TCR5SB39U		3.82	3.9	3.98	
TCR5SB40U		3.92	4.0	4.08	
TCR5SB41U		4.01	4.1	4.19	
TCR5SB42U		4.11	4.2	4.29	
TCR5SB43U		4.21	4.3	4.39	
TCR5SB44U		4.31	4.4	4.49	
TCR5SB45U	4.41	4.5	4.59		
TCR5SB46U	4.50	4.6	4.70		
TCR5SB47U	4.60	4.7	4.80		
TCR5SB48U	4.70	4.8	4.90		
TCR5SB49U	4.80	4.9	5.00		
TCR5SB50U	4.90	5.0	5.10		

## Dropout Voltage

( $I_{OUT} = 50 \text{ mA}$ ,  $C_{IN} = 0.1 \mu\text{F}$ ,  $C_{OUT} = 1.0 \mu\text{F}$ ,  $T_j = 25^\circ\text{C}$ )

Product No.	Symbol	Min	Typ.	Max	Unit
TCR5SB15U to TCR5SB16U	V <sub>IN-V<sub>OUT</sub></sub>	—	150	330	mV
TCR5SB17U to TCR5SB18U		—	130	310	
TCR5SB19U to TCR5SB23U		—	110	250	
TCR5SB24U to TCR5SB27U		—	90	200	
TCR5SB28U to TCR5SB50U		—	85	190	

## Application Note

### 1. Recommended Application Circuit

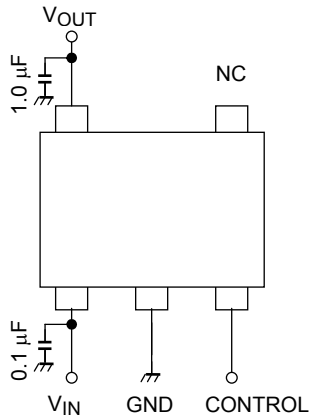

Control Level	Operation
HIGH	ON
LOW	OFF

The figure above shows the recommended configuration for using a Low-Dropout regulator. Insert a capacitor at  $V_{out}$  and  $V_{in}$  pins for stable input/output operation. (Ceramic capacitors can be used)

If the control function is not used, Toshiba recommend that the control pin is connected to the  $V_{IN}$  pin.

### 2. Power Dissipation

Power dissipation is measured on the board shown below.

### Testing Board of Thermal Resistance

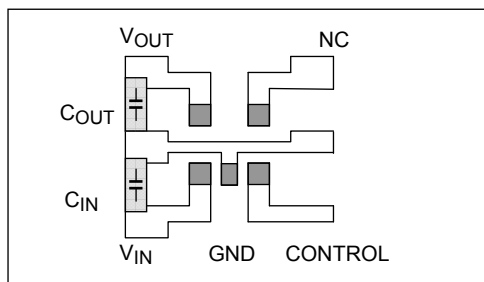

Board material: Glass Epoxy, Board dimension 30 mm × 30 mm  
Copper area: 35 mm<sup>2</sup>, t = 0.8 mm

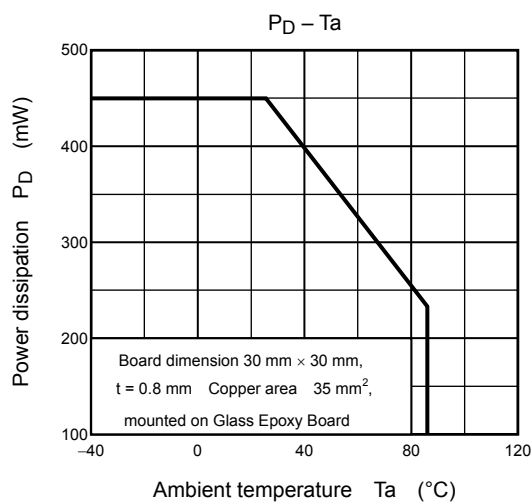

### 3. Ripple Rejection

TCR5SBxxU series are designed for superior ripple rejection characteristic. Even an output changes with steep resistance rate of the power supply voltage, characteristic of Input Transient Response, the ripple rejection shows an extremely superior characteristics. Therefore these devices are suitable for use as RF block for every cellular phone system.

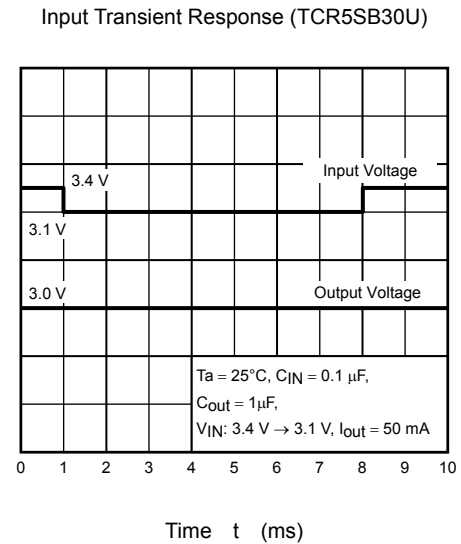
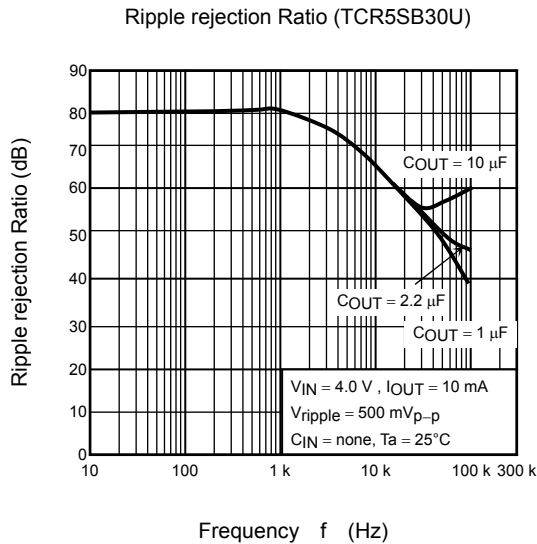

### Attention in Use

- **Output Capacitors**  
Ceramic capacitors can be used for these devices. However, because of the type of the capacitors, there might be unexpected thermal features. Please consider application condition for selecting capacitors.
- **Mounting**  
The long distance between IC and output capacitor might affect phase assurance by impedance in wire and inductor. For stable power supply, output capacitor need to mount near IC as much as possible. Also GND pattern need to be large and make the wire impedance small as possible.
- **Permissible Loss**  
Please have enough design patterns for expected maximum permissible loss. And under consideration of surrounding temperature, input voltage, and output current etc, we recommend proper dissipation ratings for maximum permissible loss; in general maximum dissipation rating is 70 to 80 percent.
- **Overcurrent Protection Circuit**  
Overcurrent protection circuit is designed in these products, but this does not assure for the suppression of uprising device operation. If output pins and GND pins are shorted out, these products might be break down.

In use of these products, please read through and understand dissipation idea for absolute maximum ratings from the above mention or our 'Semiconductor Reliability Handbook'. Then use these products under absolute maximum ratings in any condition. Furthermore, Toshiba recommend inserting failsafe system into the design.

## Representative Typical Characteristics

### 1) Output Voltage vs. Input Voltage

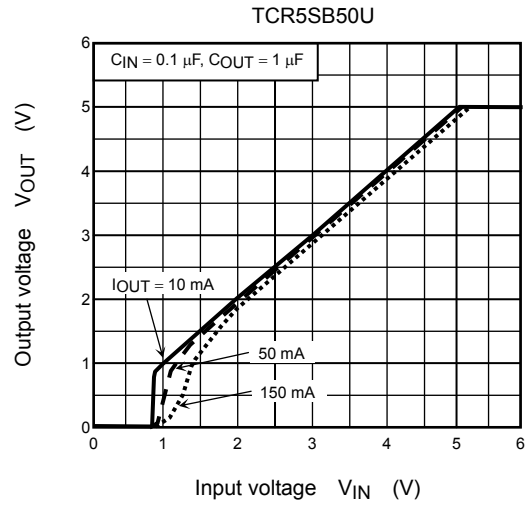
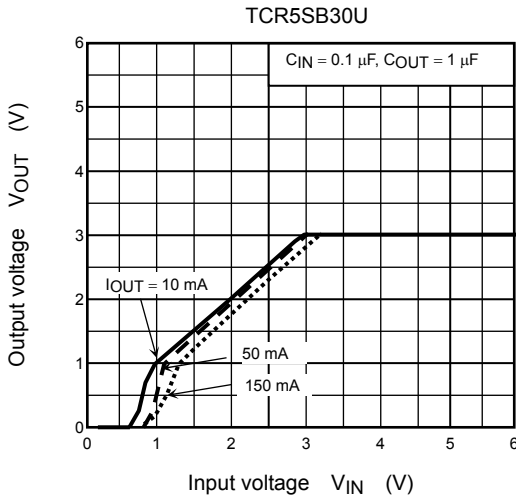
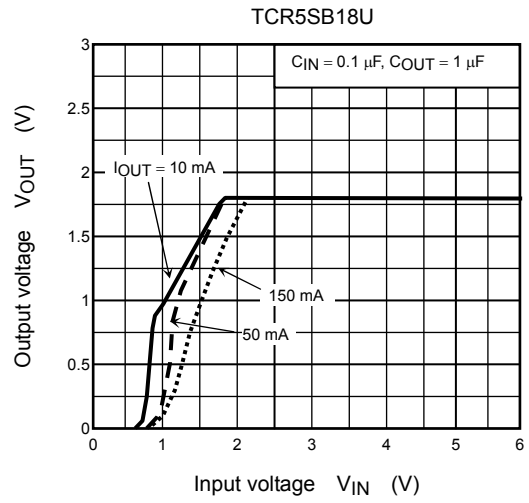
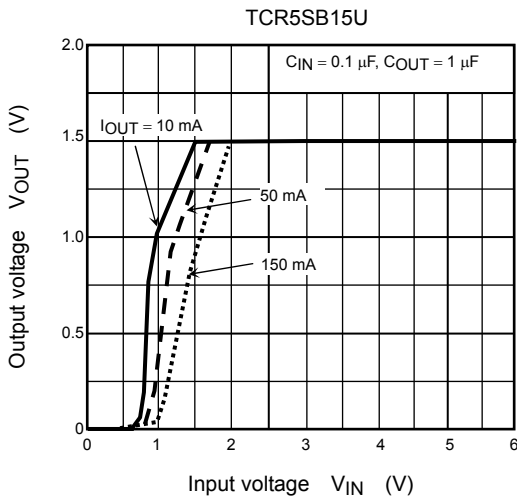

### 2) Output Voltage vs. Output Current

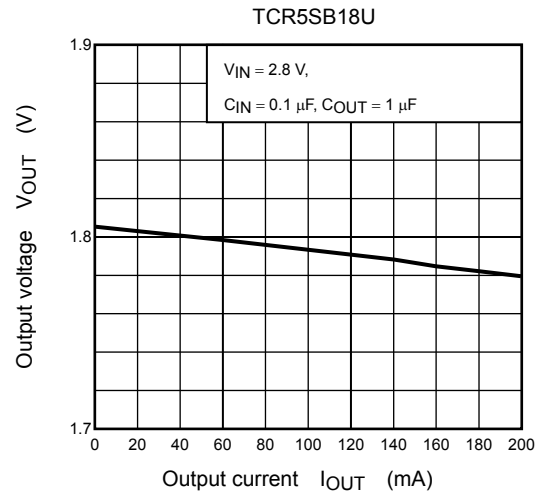
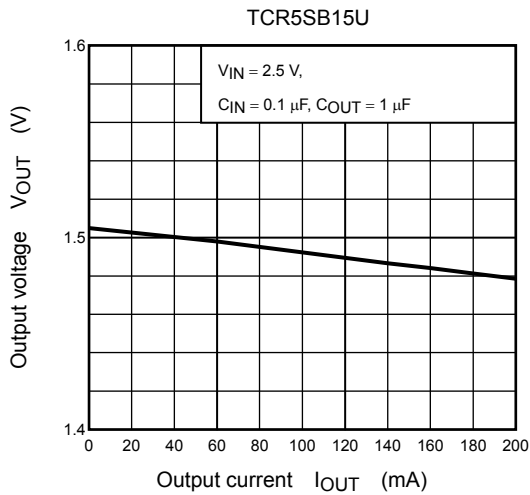



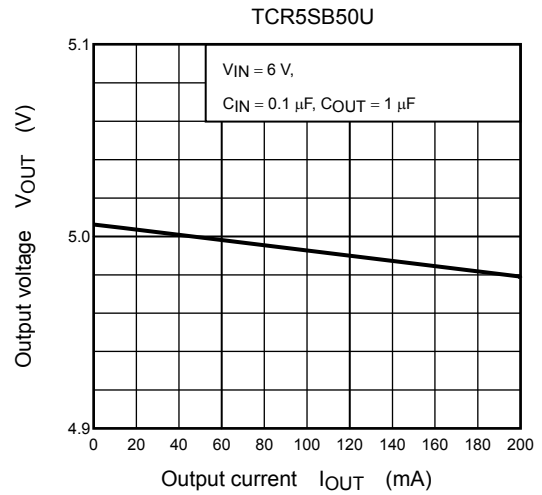
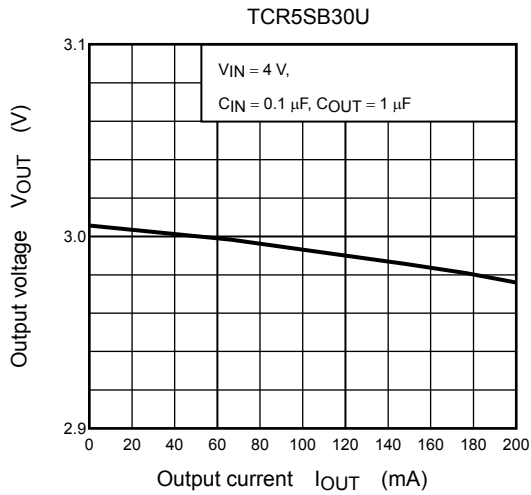

3) Output Voltage vs. Ambient temperature

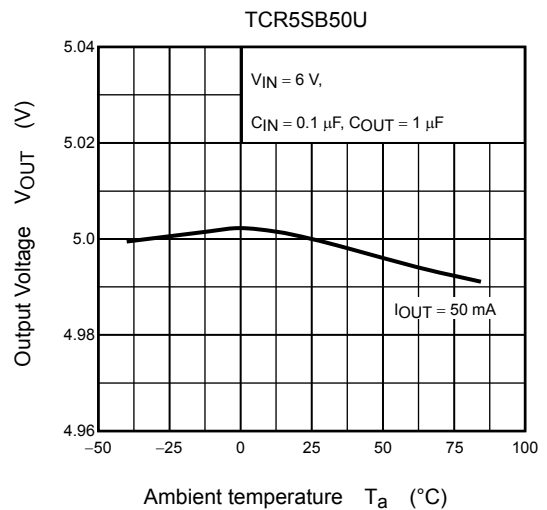
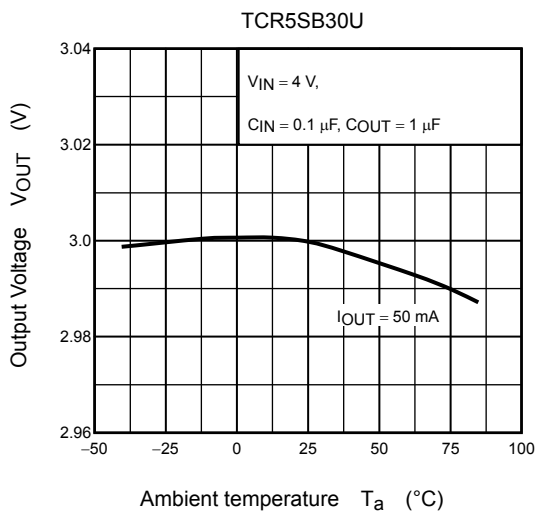
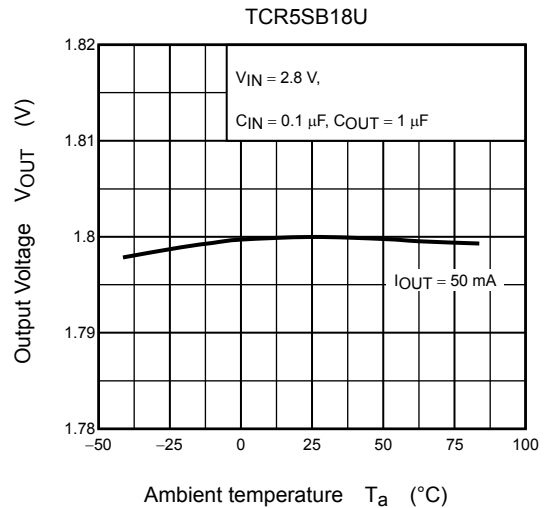
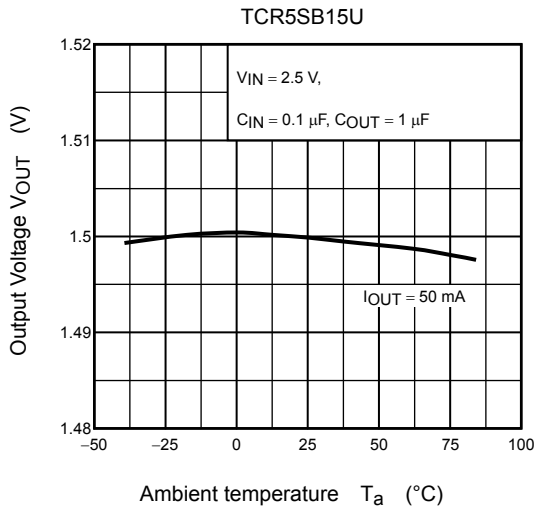

### 4) Dropout Voltage vs. Output Current

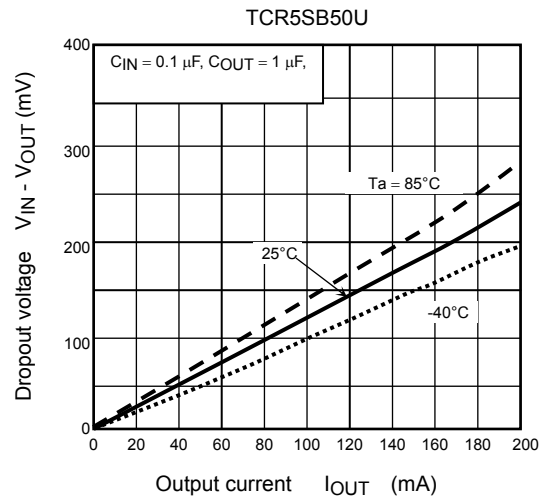
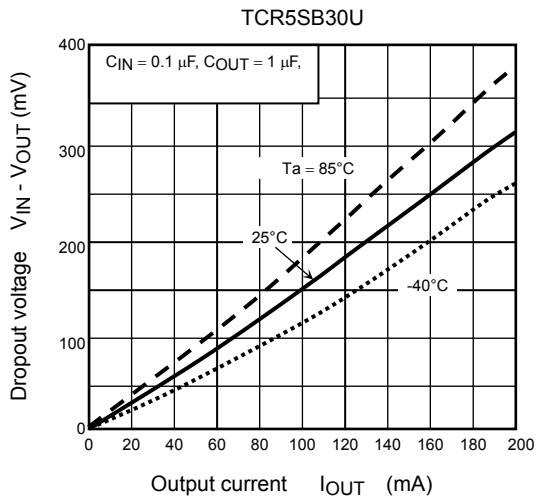

### 5) Quiescent Current vs. Input Voltage

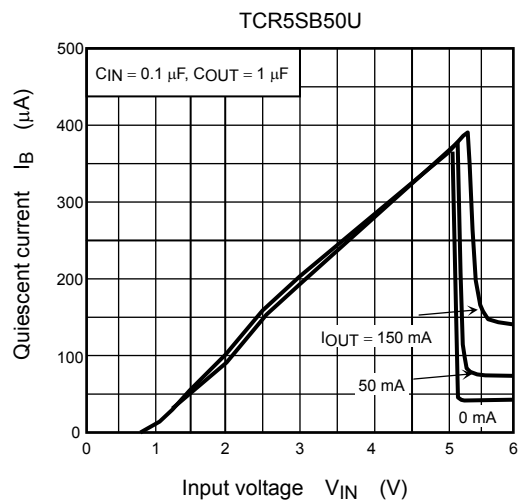
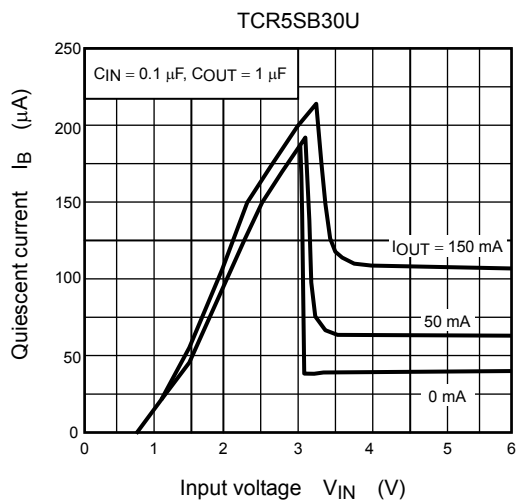
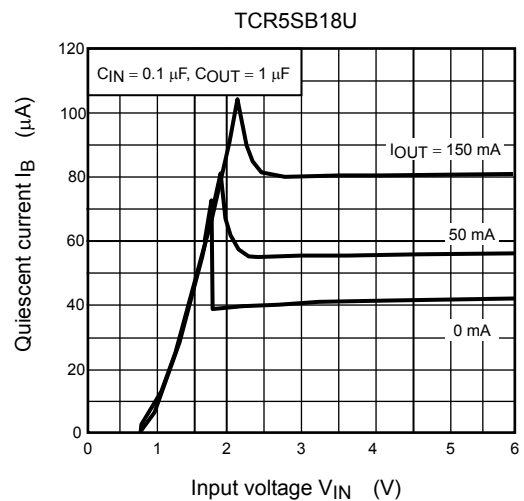
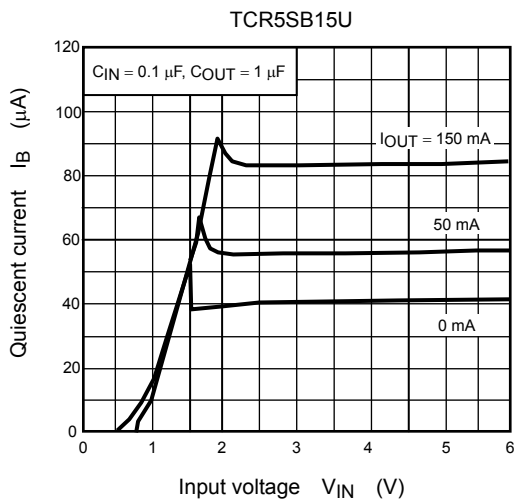

6) Quiescent Current vs. Ambient temperature

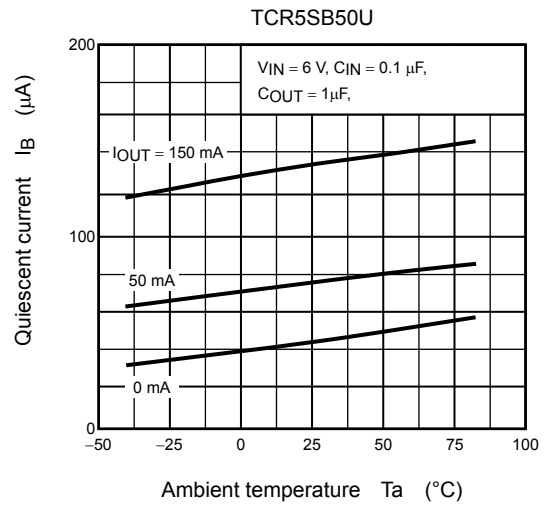
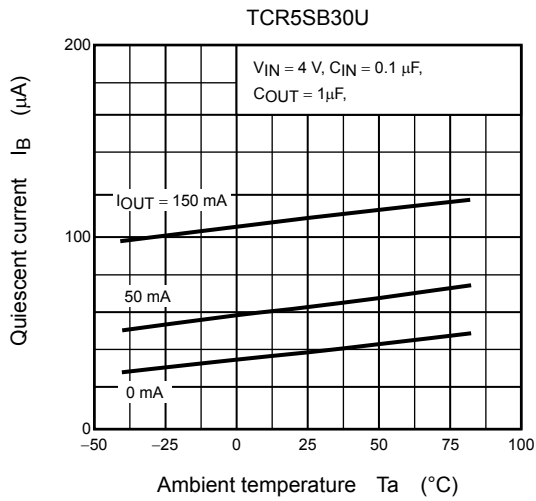
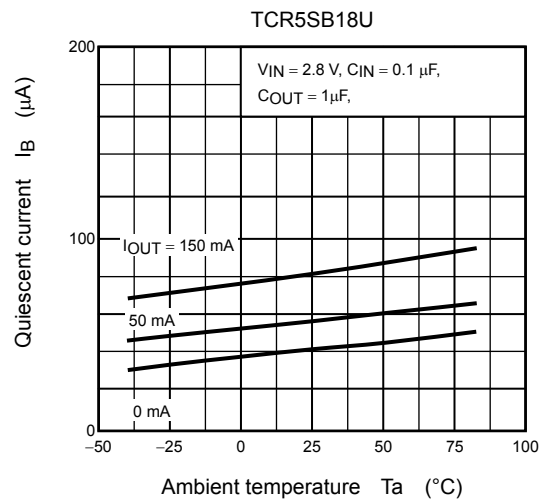
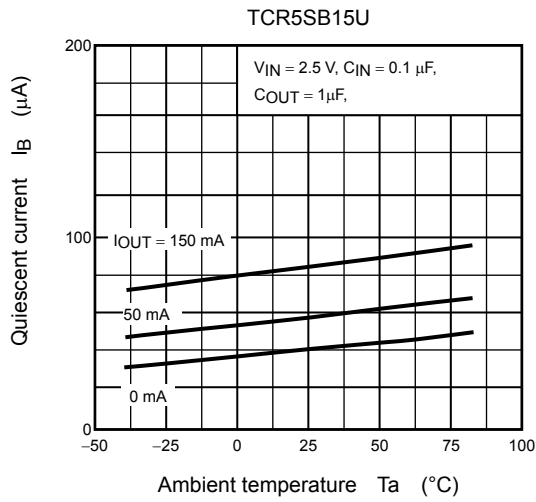

7) Overcurrent Protection Characteristics

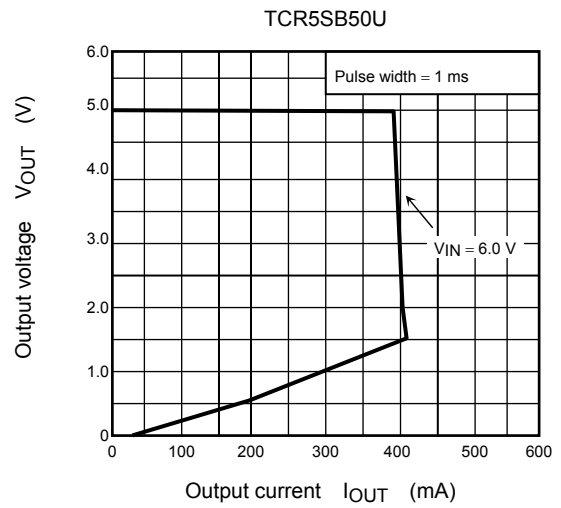
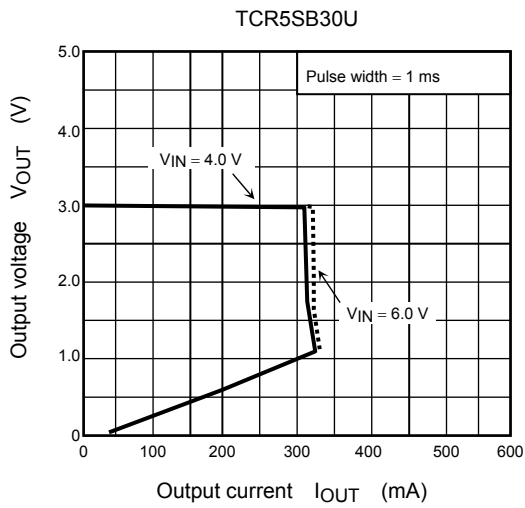
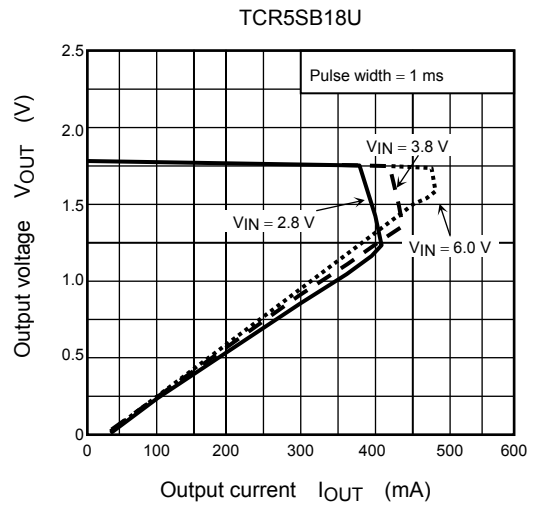
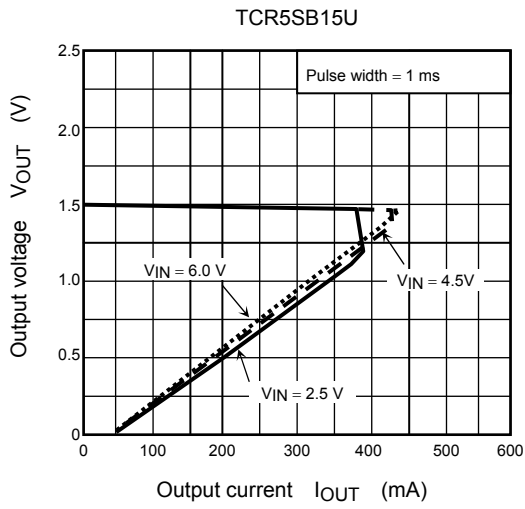

### 8) Ripple rejection Ratio vs. Frequency (Dependence of Output current)

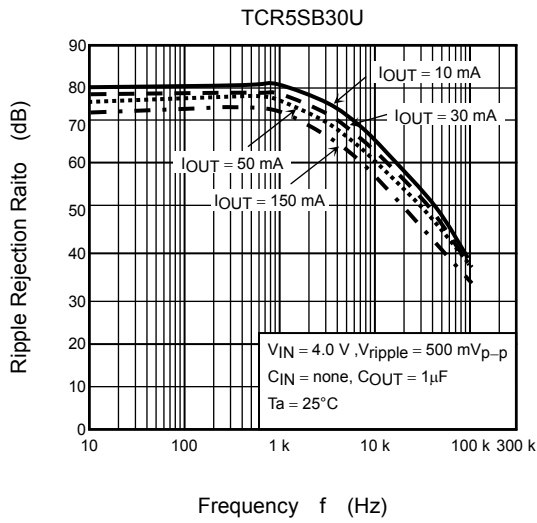

### 9) Ripple rejection Ratio vs. Input Voltage

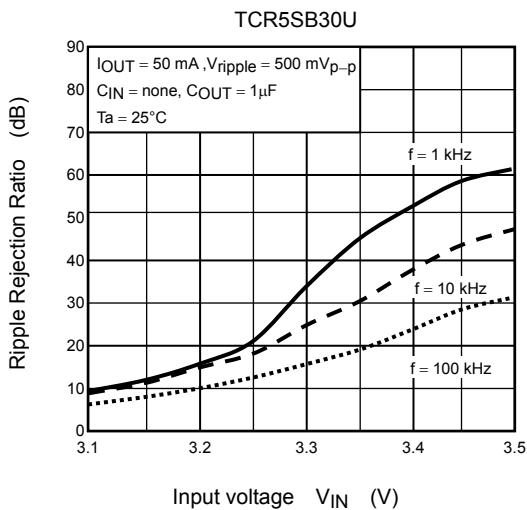
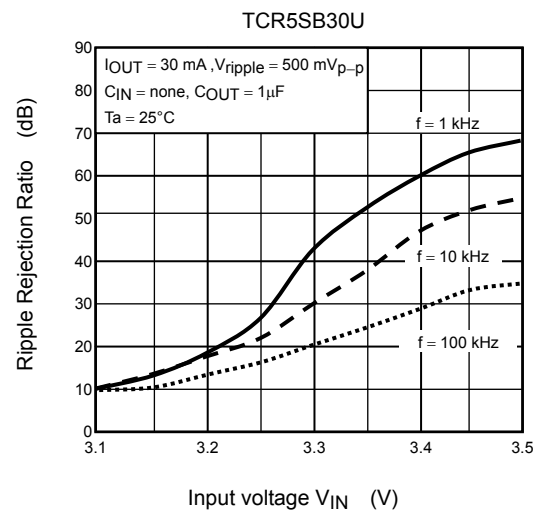
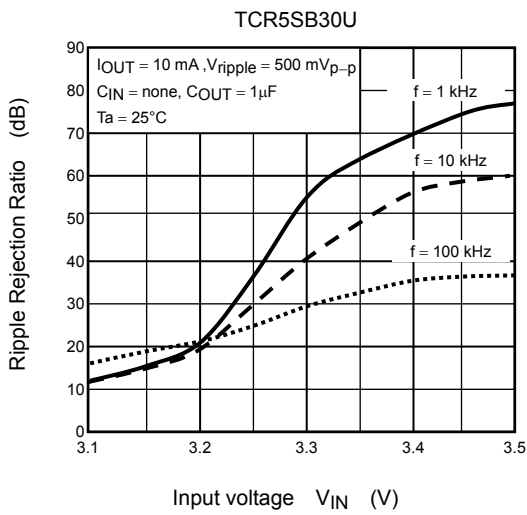

## 10) Control Transient Response

TCR5SB15U (Turn on wave form)

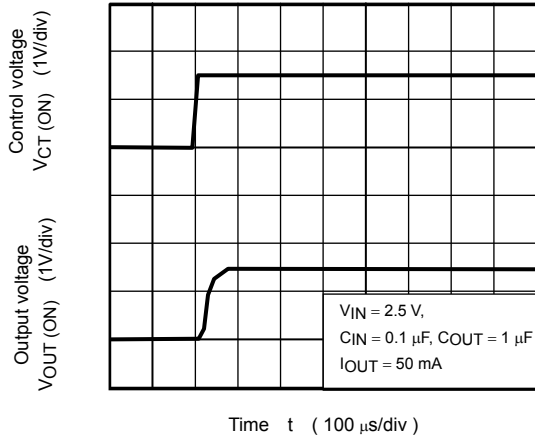

TCR5SB15U (Turn off wave form)

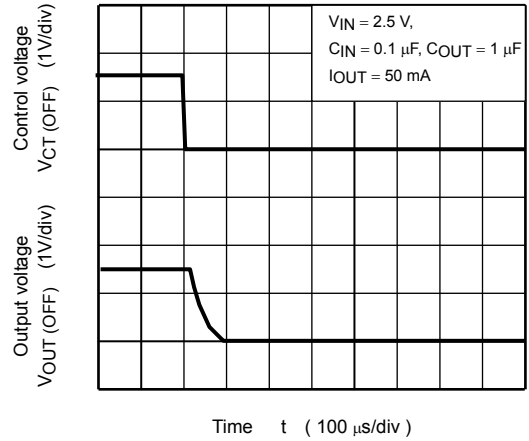

TCR5SB30U (Turn on wave form)

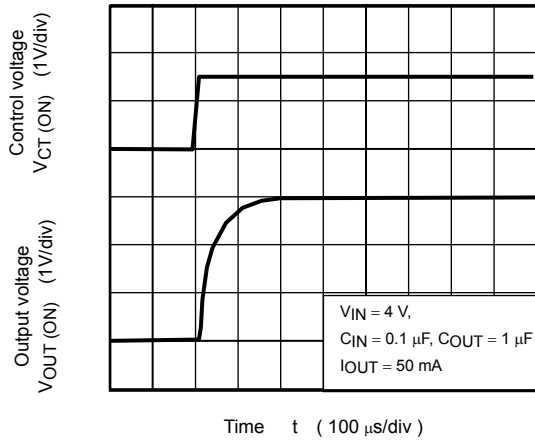

TCR5SB30U (Turn off wave form)

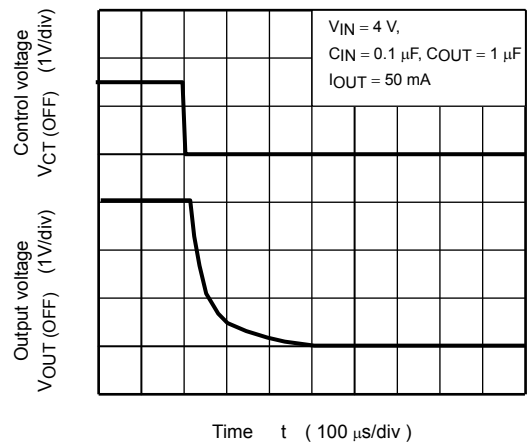

TCR5SB50U (Turn on wave form)

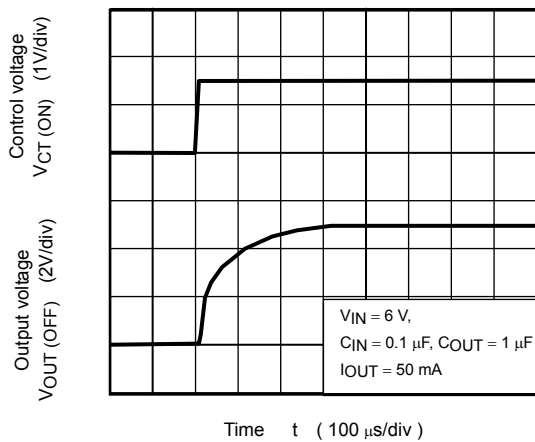

TCR5SB50U (Turn off wave form)

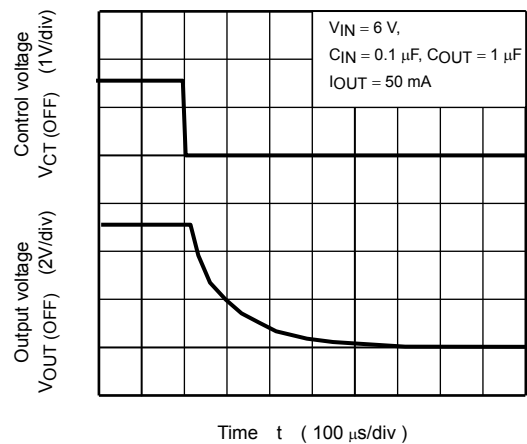

## 11) Load Transient Response

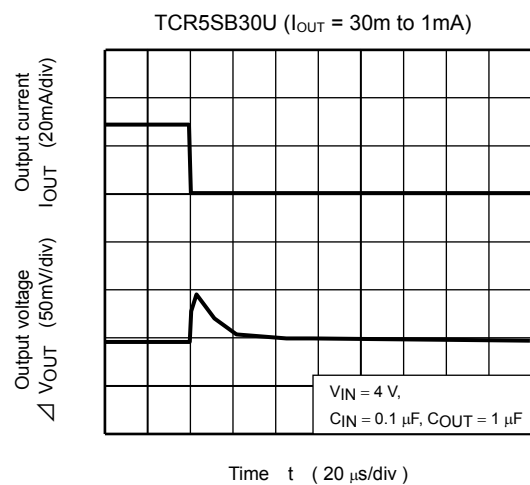
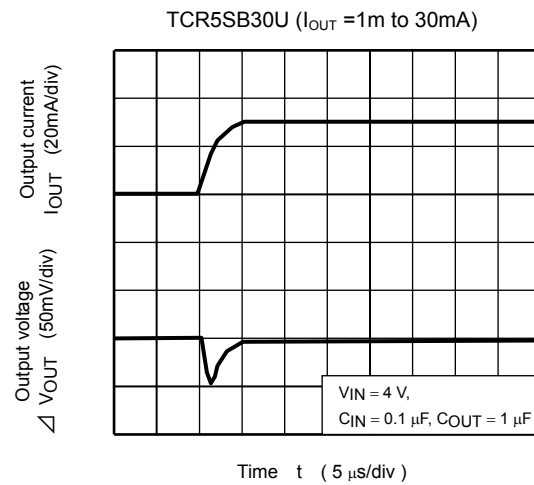
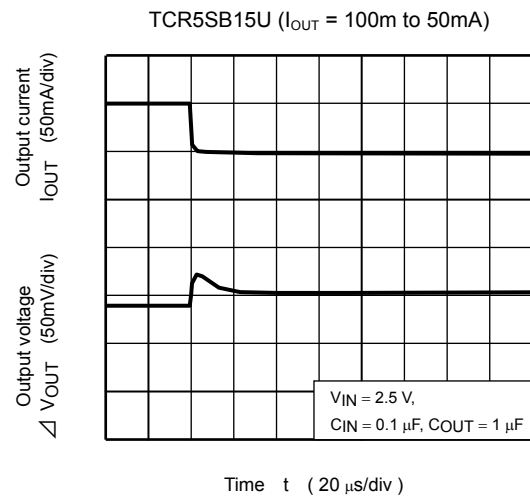
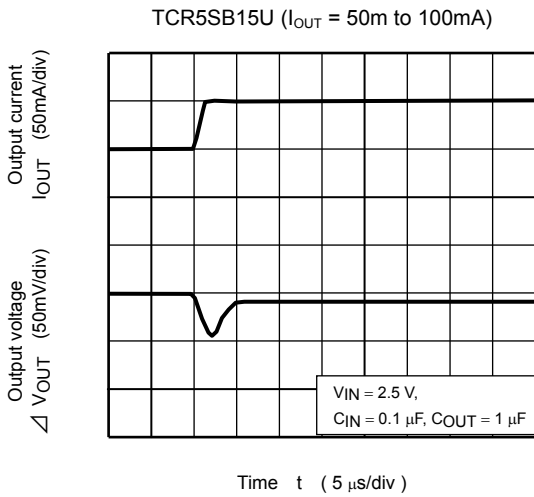
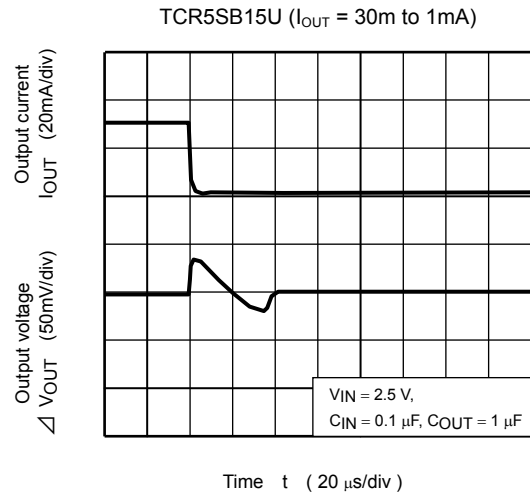
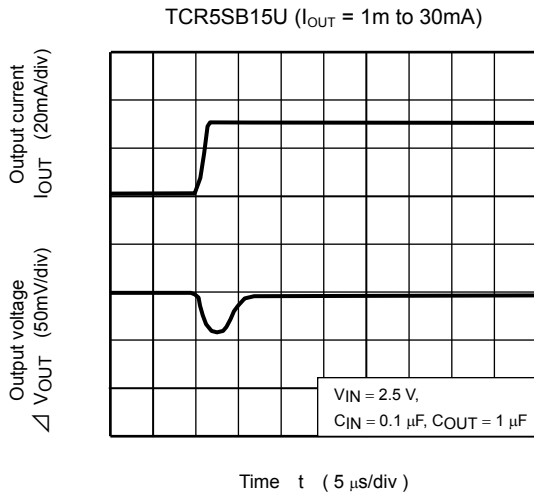

TCR5SB30U ( $I_{OUT} = 50\text{m to }100\text{mA}$ )

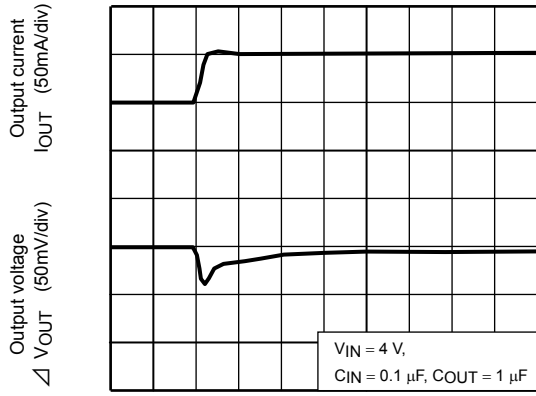

Time t (5  $\mu\text{s/div}$ )

TCR5SB30U ( $I_{OUT} = 100\text{m to }50\text{mA}$ )

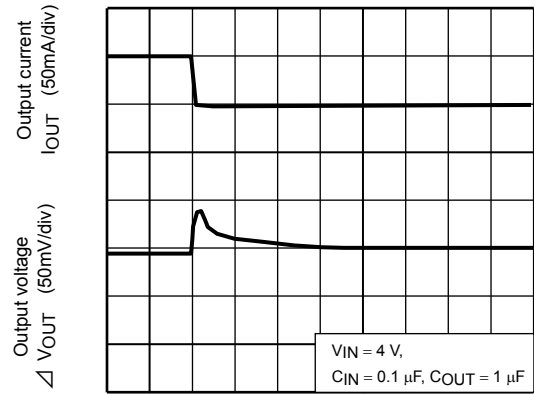

Time t (20  $\mu\text{s/div}$ )

TCR5SB50U ( $I_{OUT} = 1\text{m to }30\text{mA}$ )

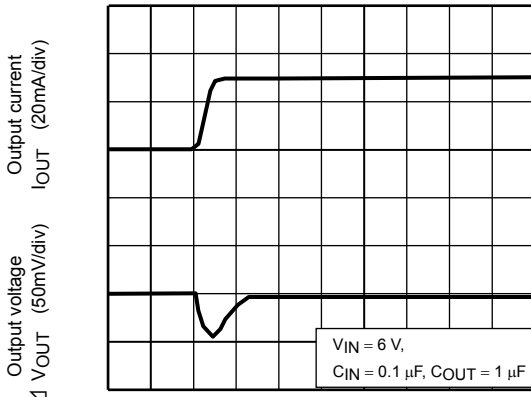

Time t (5  $\mu\text{s/div}$ )

TCR5SB50U ( $I_{OUT} = 30\text{m to }1\text{mA}$ )

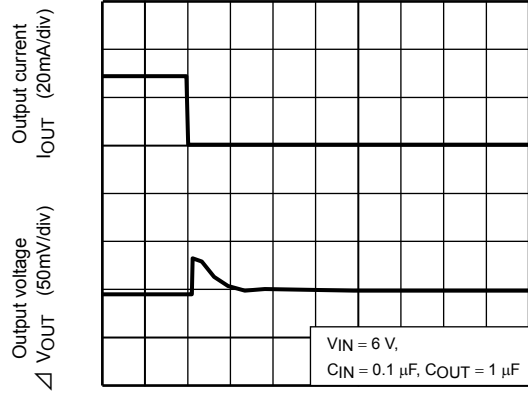

Time t (20  $\mu\text{s/div}$ )

TCR5SB50U ( $I_{OUT} = 50\text{m to }100\text{mA}$ )

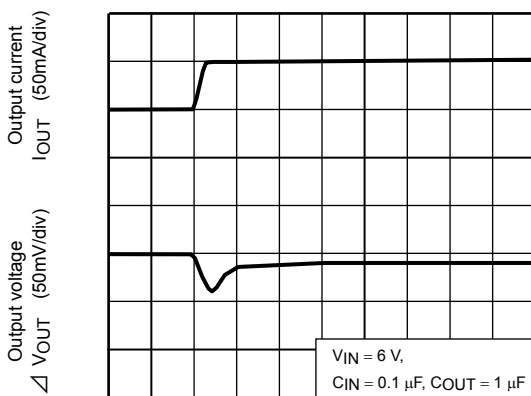

Time t (5  $\mu\text{s/div}$ )

TCR5SB50U ( $I_{OUT} = 100\text{m to }50\text{mA}$ )

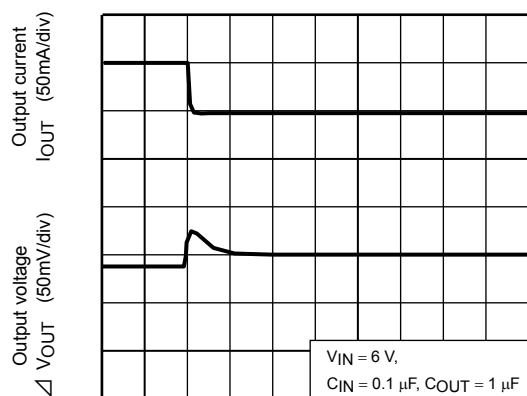

Time t (20  $\mu\text{s/div}$ )



## Package Dimensions

UFV

Unit: mm

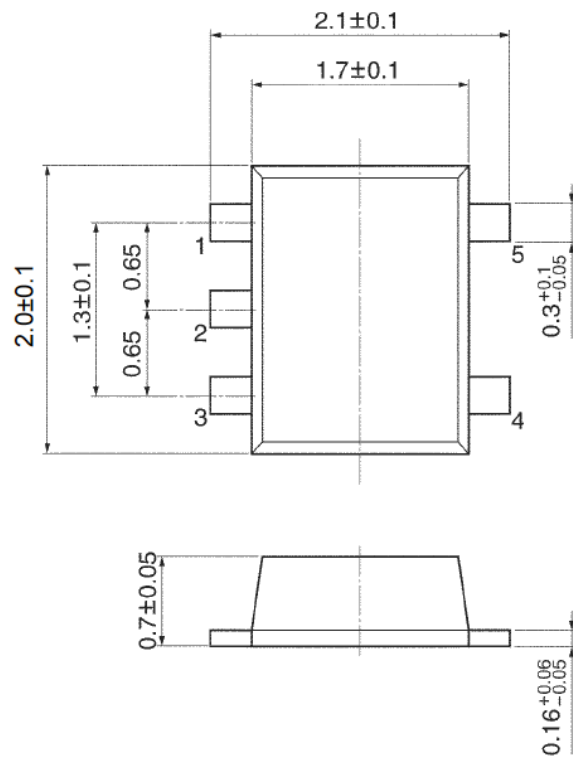

Weight: 0.007 g (typ)

**RESTRICTIONS ON PRODUCT USE**

- Toshiba Corporation, and its subsidiaries and affiliates (collectively "TOSHIBA"), reserve the right to make changes to the information in this document, and related hardware, software and systems (collectively "Product") without notice.
- This document and any information herein may not be reproduced without prior written permission from TOSHIBA. Even with TOSHIBA's written permission, reproduction is permissible only if reproduction is without alteration/omission.
- Though TOSHIBA works continually to improve Product's quality and reliability, Product can malfunction or fail. Customers are responsible for complying with safety standards and for providing adequate designs and safeguards for their hardware, software and systems which minimize risk and avoid situations in which a malfunction or failure of Product could cause loss of human life, bodily injury or damage to property, including data loss or corruption. Before customers use the Product, create designs including the Product, or incorporate the Product into their own applications, customers must also refer to and comply with (a) the latest versions of all relevant TOSHIBA information, including without limitation, this document, the specifications, the data sheets and application notes for Product and the precautions and conditions set forth in the "TOSHIBA Semiconductor Reliability Handbook" and (b) the instructions for the application with which the Product will be used with or for. Customers are solely responsible for all aspects of their own product design or applications, including but not limited to (a) determining the appropriateness of the use of this Product in such design or applications; (b) evaluating and determining the applicability of any information contained in this document, or in charts, diagrams, programs, algorithms, sample application circuits, or any other referenced documents; and (c) validating all operating parameters for such designs and applications. **TOSHIBA ASSUMES NO LIABILITY FOR CUSTOMERS' PRODUCT DESIGN OR APPLICATIONS.**
- Product is intended for use in general electronics applications (e.g., computers, personal equipment, office equipment, measuring equipment, industrial robots and home electronics appliances) or for specific applications as expressly stated in this document. Product is neither intended nor warranted for use in equipment or systems that require extraordinarily high levels of quality and/or reliability and/or a malfunction or failure of which may cause loss of human life, bodily injury, serious property damage or serious public impact ("Unintended Use"). Unintended Use includes, without limitation, equipment used in nuclear facilities, equipment used in the aerospace industry, medical equipment, equipment used for automobiles, trains, ships and other transportation, traffic signaling equipment, equipment used to control combustions or explosions, safety devices, elevators and escalators, devices related to electric power, and equipment used in finance-related fields. Do not use Product for Unintended Use unless specifically permitted in this document.
- Do not disassemble, analyze, reverse-engineer, alter, modify, translate or copy Product, whether in whole or in part.
- Product shall not be used for or incorporated into any products or systems whose manufacture, use, or sale is prohibited under any applicable laws or regulations.
- The information contained herein is presented only as guidance for Product use. No responsibility is assumed by TOSHIBA for any infringement of patents or any other intellectual property rights of third parties that may result from the use of Product. No license to any intellectual property right is granted by this document, whether express or implied, by estoppel or otherwise.
- **ABSENT A WRITTEN SIGNED AGREEMENT, EXCEPT AS PROVIDED IN THE RELEVANT TERMS AND CONDITIONS OF SALE FOR PRODUCT, AND TO THE MAXIMUM EXTENT ALLOWABLE BY LAW, TOSHIBA (1) ASSUMES NO LIABILITY WHATSOEVER, INCLUDING WITHOUT LIMITATION, INDIRECT, CONSEQUENTIAL, SPECIAL, OR INCIDENTAL DAMAGES OR LOSS, INCLUDING WITHOUT LIMITATION, LOSS OF PROFITS, LOSS OF OPPORTUNITIES, BUSINESS INTERRUPTION AND LOSS OF DATA, AND (2) DISCLAIMS ANY AND ALL EXPRESS OR IMPLIED WARRANTIES AND CONDITIONS RELATED TO SALE, USE OF PRODUCT, OR INFORMATION, INCLUDING WARRANTIES OR CONDITIONS OF MERCHANTABILITY, FITNESS FOR A PARTICULAR PURPOSE, ACCURACY OF INFORMATION, OR NONINFRINGEMENT.**
- Do not use or otherwise make available Product or related software or technology for any military purposes, including without limitation, for the design, development, use, stockpiling or manufacturing of nuclear, chemical, or biological weapons or missile technology products (mass destruction weapons). Product and related software and technology may be controlled under the Japanese Foreign Exchange and Foreign Trade Law and the U.S. Export Administration Regulations. Export and re-export of Product or related software or technology are strictly prohibited except in compliance with all applicable export laws and regulations.
- Please contact your TOSHIBA sales representative for details as to environmental matters such as the RoHS compatibility of Product. Please use Product in compliance with all applicable laws and regulations that regulate the inclusion or use of controlled substances, including without limitation, the EU RoHS Directive. TOSHIBA assumes no liability for damages or losses occurring as a result of noncompliance with applicable laws and regulations.