

TCR4S12DWBG~TCR4S36DWBG

200 mA CMOS Low-Dropout Regulator

The TCR4S12DWBG to TCR4S36DWBG are CMOS general-purpose single-output voltage regulators with an on/off control input, featuring low dropout voltage and low quiescent bias current. The TCR4S12DWBG to TCR4S36DWBG can be enabled and disabled via the CONTROL pin.

These voltage regulators are available in fixed output voltages between 1.2 V and 3.6 V in 0.05-V steps and capable of driving up to 200 mA. They feature overcurrent protection and auto-discharge.

The TCR4S12DWBG to TCR4S36DWBG are offered in the compact WCSP (0.79 mm x 0.79 mm x 0.50 mm) and allow the use of small ceramic input and output capacitors. Thus, these devices are ideal for portable applications that require high-density board assembly such as cellular phones.

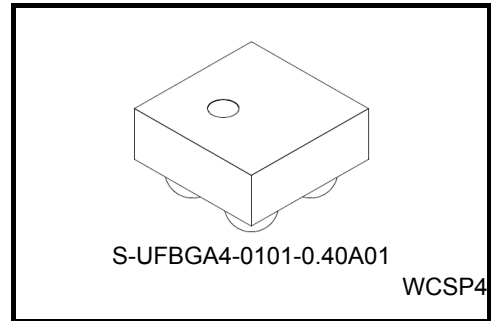

Weight: 0.7 mg (typ)

Features

- Low quiescent bias current ($I_B = 50 \mu A$ (typ.) at $I_{OUT} = 0 \text{ mA}$)
- Low stand-by current ($I_{B(OFF)} = 0.1 \mu A$ (typ.) at Stand-by mode)
- Low dropout voltage ($V_{IN} - V_{OUT} = 90 \text{ mV}$ (typ.) at TCR4S25DWBG, $I_{OUT} = 50 \text{ mA}$)
- High ripple rejection ratio (R.R = 80 dB (typ) at $I_{OUT} = 10 \text{ mA}$, $f = 1\text{kHz}$)
- Low output noise voltage ($V_{NO} = 30 \mu V_{rms}$ (typ.) at TCR4S25DWBG, $I_{OUT} = 10 \text{ mA}$, $10 \text{ Hz} \leq f \leq 100 \text{ kHz}$)
- Auto-discharge
- Control pull-down resistor
- Overcurrent protection
- Ceramic capacitors can be used ($C_{IN} = 0.1 \mu F$, $C_{OUT} = 1.0 \mu F$)
- Very small package, WCSP (0.79 mm x 0.79 mm x 0.50 mm)

Pin Assignment (top view)

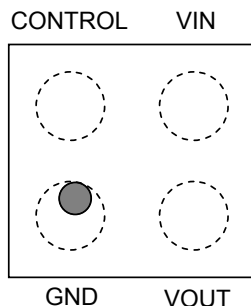

List of Products Number and Marking

Products No.	Marking	Products No.	Marking
TCR4S12DWBG	B3	TCR4S26DWBG	BN
TCR4S13DWBG	B4	TCR4S27DWBG	BO
TCR4S14DWBG	B5	TCR4S28DWBG	BP
TCR4S15DWBG	BA	TCR4S285DWBG	B7
TCR4S16DWBG	BB	TCR4S29DWBG	BR
TCR4S17DWBG	BD	TCR4S295DWBG	B6
TCR4S18DWBG	BE	TCR4S30DWBG	BS
TCR4S19DWBG	BF	TCR4S31DWBG	BT
TCR4S20DWBG	BG	TCR4S32DWBG	BV
TCR4S21DWBG	BH	TCR4S33DWBG	BW
TCR4S22DWBG	BI	TCR4S34DWBG	BX
TCR4S23DWBG	BK	TCR4S35DWBG	BY
TCR4S24DWBG	BL	TCR4S36DWBG	BZ
TCR4S25DWBG	BM		

Marking (top view)

Example: TCR4S15DWBG (1.5 V output)

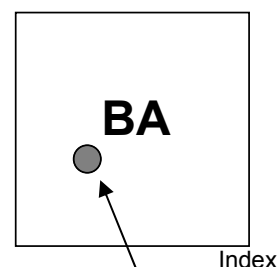

Absolute Maximum Ratings (Ta = 25°C)

Characteristics	Symbol	Rating	Unit
Input voltage	V_{IN}	6 (Note 1)	V
Control voltage	V_{CT}	-0.3 to V_{IN}	V
Output voltage	V_{OUT}	-0.3 to $V_{IN} + 0.3$	V
Output current	I_{OUT}	200	mA
Power dissipation	P_D	800 (Note 2)	mW
Operation temperature range	T_{opr}	-40 to 85	°C
Junction temperature	T_j	150	°C
Storage temperature range	T_{stg}	-55 to 150	°C

Note: Using continuously under heavy loads (e.g. the application of high temperature/current/voltage and the significant change in temperature, etc.) may cause this product to decrease in the reliability significantly even if the operating conditions (i.e. operating temperature/current/voltage, etc.) are within the absolute maximum ratings and the operating ranges.

Please design the appropriate reliability upon reviewing the Toshiba Semiconductor Reliability Handbook ("Handling Precautions"/"Derating Concept and Methods") and individual reliability data (i.e. reliability test report and estimated failure rate, etc).

(Note 1): V_{IN} for 1.2 V to 1.4V output product is 5.5 V.

(Note 2): Rating at mounting on a board
 (Glass epoxy board dimension: 40mm x 40mm, both sides of board
 Wireability: a surface approximately 50%, the reverse side approximately 50%
 Through hole hall: diameter 0.5mm x 28)

Electrical Characteristics

(Unless otherwise specified,

$V_{IN} = V_{OUT} + 1\text{ V}$, $I_{OUT} = 50\text{ mA}$, $C_{IN} = 0.1\text{ }\mu\text{F}$, $C_{OUT} = 1.0\text{ }\mu\text{F}$, $T_j = 25^\circ\text{C}$)(Note 3)

Characteristics	Symbol	Test Condition	Min	Typ.	Max	Unit	
Output voltage	V_{OUT}	Please refer to the Output Voltage Accuracy table					
Line regulation	Reg·line	$V_{OUT} + 0.5\text{ V} \leq V_{IN} \leq 6\text{ V}$, $I_{OUT} = 1\text{ mA}$ (Note 4)	—	1	15	mV	
Load regulation	Reg·load	$1\text{ mA} \leq I_{OUT} \leq 150\text{ mA}$	—	5	30	mV	
Quiescent current	I_B	$I_{OUT} = 0\text{ mA}$	—	50	75	μA	
Stand-by current	I_B (OFF)	$V_{CT} = 0\text{ V}$	—	0.1	1.0	μA	
Dropout voltage	$V_{IN}-V_{OUT}$	Please refer to the Dropout voltage table					
Temperature coefficient	T_{CVO}	$-40^\circ\text{C} \leq T_{opr} \leq 85^\circ\text{C}$	—	100	—	ppm/ $^\circ\text{C}$	
Output noise voltage	V_{NO}	$V_{IN} = V_{OUT} + 1\text{ V}$, $I_{OUT} = 10\text{ mA}$, $10\text{ Hz} \leq f \leq 100\text{ kHz}$, $T_a = 25^\circ\text{C}$	TCR4S12DWBG to TCR4S20DWBG	—	25	—	μV_{rms}
			TCR4S21DWBG to TCR4S30DWBG	—	30	—	
			TCR4S31DWBG to TCR4S36DWBG	—	35	—	
Input voltage	V_{IN}	—	TCR4S12DWBG	1.8	—	5.5	V
			TCR4S13DWBG to TCR4S14DWBG	1.85	—	5.5	
			TCR4S15DWBG to TCR4S19DWBG	$V_{OUT} + 0.35\text{ V}$	—	6.0	
			TCR4S20DWBG to TCR4S21DWBG	$V_{OUT} + 0.28\text{ V}$	—	6.0	
			TCR4S22DWBG to TCR4S24DWBG	$V_{OUT} + 0.25\text{ V}$	—	6.0	
			TCR4S25DWBG to TCR4S36DWBG	$V_{OUT} + 0.20\text{ V}$	—	6.0	
Ripple rejection ratio	R.R.	$V_{IN} = V_{OUT} + 1\text{ V}$, $I_{OUT} = 10\text{ mA}$, $f = 1\text{ kHz}$, $V_{Ripple} = 500\text{ mV}_{p-p}$, $T_a = 25^\circ\text{C}$	—	80	—	dB	
Control voltage (ON)	V_{CT} (ON)	(Note 5)	1.1	—	6.0	V	
Control voltage (OFF)	V_{CT} (OFF)	—	0	—	0.4	V	

Note 3: Unless otherwise specified, V_{IN} for 1.2V to 1.4V output product is $V_{OUT} + 0.5\text{ V}$

Note 4: V_{IN} for 1.2V to 1.4V output product is $V_{OUT} + 0.5\text{ V} \leq V_{IN} \leq 5.5\text{ V}$

Note 5: V_{CT} (ON) of 1.2V to 1.4V output product is 5.5V (max)

Output Voltage Accuracy

($V_{IN} = V_{OUT} + 1\text{ V}$, $I_{OUT} = 50\text{ mA}$, $C_{IN} = 0.1\text{ }\mu\text{F}$, $C_{OUT} = 1.0\text{ }\mu\text{F}$, $T_j = 25^\circ\text{C}$)

Product No.	Symbol	Min	Typ.	Max	Unit
TCR4S12DWBG	V _{OUT}	1.17	1.2	1.23	V
TCR4S13DWBG		1.27	1.3	1.33	
TCR4S14DWBG		1.37	1.4	1.43	
TCR4S15DWBG		1.47	1.5	1.53	
TCR4S16DWBG		1.56	1.6	1.64	
TCR4S17DWBG		1.66	1.7	1.74	
TCR4S18DWBG		1.76	1.8	1.84	
TCR4S19DWBG		1.86	1.9	1.94	
TCR4S20DWBG		1.96	2.0	2.04	
TCR4S21DWBG		2.05	2.1	2.15	
TCR4S22DWBG		2.15	2.2	2.25	
TCR4S23DWBG		2.25	2.3	2.35	
TCR4S24DWBG		2.35	2.4	2.45	
TCR4S25DWBG		2.45	2.5	2.55	
TCR4S26DWBG		2.54	2.6	2.66	
TCR4S27DWBG		2.64	2.7	2.76	
TCR4S28DWBG		2.74	2.8	2.86	
TCR4S285DWBG		2.79	2.85	2.91	
TCR4S29DWBG		2.84	2.9	2.96	
TCR4S295DWBG		2.89	2.95	3.01	
TCR4S30DWBG		2.94	3.0	3.06	
TCR4S31DWBG		3.03	3.1	3.17	
TCR4S32DWBG		3.13	3.2	3.27	
TCR4S33DWBG		3.23	3.3	3.37	
TCR4S34DWBG	3.33	3.4	3.47		
TCR4S35DWBG	3.43	3.5	3.57		
TCR4S36DWBG	3.52	3.6	3.68		

Dropout Voltage

($I_{OUT} = 50\text{ mA}$, $C_{IN} = 0.1\text{ }\mu\text{F}$, $C_{OUT} = 1.0\text{ }\mu\text{F}$, $T_j = 25^\circ\text{C}$)

Product No.	Symbol	Min	Typ.	Max	Unit
TCR4S12DWBG	V _{IN-V_{OUT}}	—	400	600	mV
TCR4S13DWBG		—	350	550	
TCR4S14DWBG		—	300	450	
TCR4S15DWBG to TCR4S19DWBG		—	200	350	
TCR4S20DWBG to TCR4S21DWBG		—	150	280	
TCR4S22DWBG to TCR4S24DWBG		—	130	250	
TCR4S25DWBG to TCR4S36DWBG		—	90	200	

Application Note

1. Recommended Application (top view)

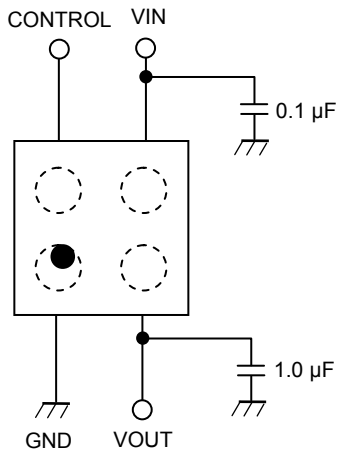

Control Level	Operation
HIGH	ON
LOW	OFF

The figure above shows the recommended configuration for using a Low-Dropout regulator. Insert a capacitor to V_{OUT} and V_{IN} for stable input/output operation. (ceramic capacitors can be used)

2. Power Dissipation

Power dissipation is measured on the board condition shown below.

[The Board Condition]

Board material: Glass epoxy

Board dimension: 40 mm x 40 mm , both sides of board , t=1.8 mm

Wireability: a surface approximately 50%

the reverse side approximately 50%

Through hole hall: diameter 0.5 mm x 28

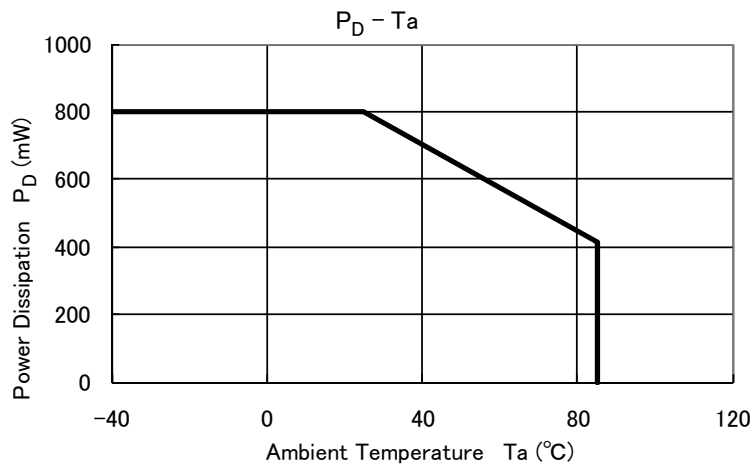

Attention in Use

- **Output Capacitors**
Ceramic capacitors can be used for these devices. However, because of the type of the capacitors, there might be unexpected thermal features. Please consider application condition for selecting capacitors. And Toshiba recommend the ESR of ceramic capacitor is under 10 Ω .

- **Mounting**
The long distance between IC and output capacitor might affect phase assurance by impedance in wire and inductor. For stable power supply, output capacitor need to mount near IC as much as possible. Also GND pattern need to be large and make the wire impedance small as possible.

- **Permissible Loss**
Please have enough board design patterns for expected maximum permissible loss. And under consideration of surrounding temperature, input voltage, and output current etc, please apply proper dissipation ratings for maximum permissible loss.

- **Overcurrent Protection Circuit**
Overcurrent protection circuit is designed in these products, but this does not assure for the suppression of uprising device operation. If output pins and GND pins are shorted out, these products might be break down.
In use of these products, please read through and understand dissipation idea for absolute maximum ratings from the above mention or our 'Semiconductor Reliability Handbook'. Then use these products under absolute maximum ratings in any condition. Furthermore, Toshiba recommend inserting failsafe system into the design.

Representative Typical Characteristics

1) Output Voltage vs. Input Voltage

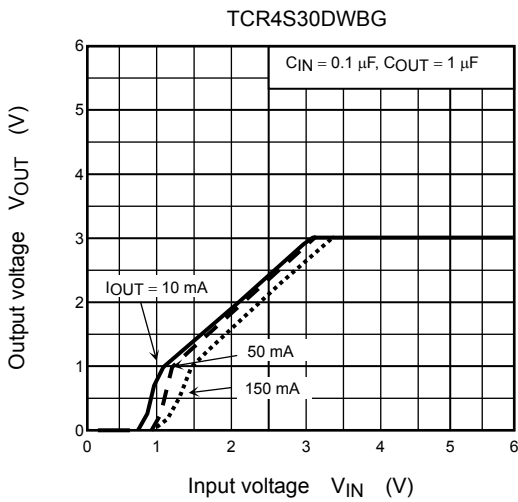
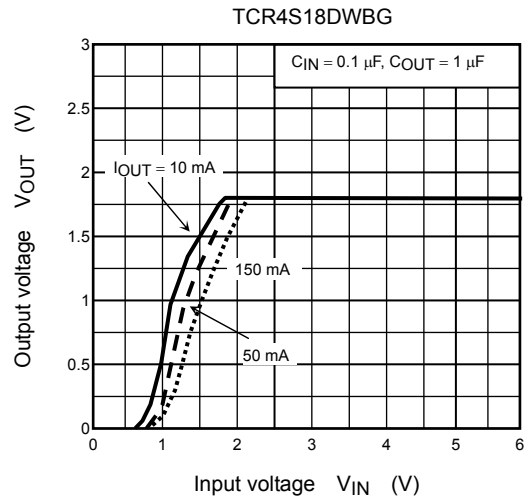
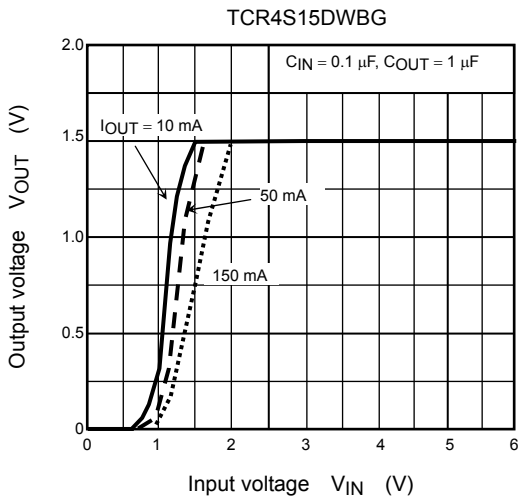

2) Output Voltage vs. Output Current

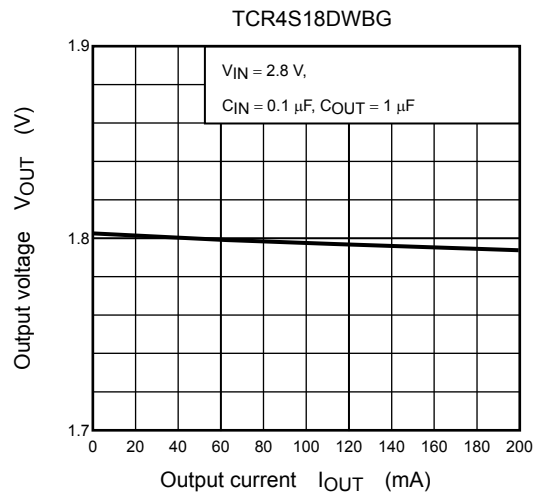
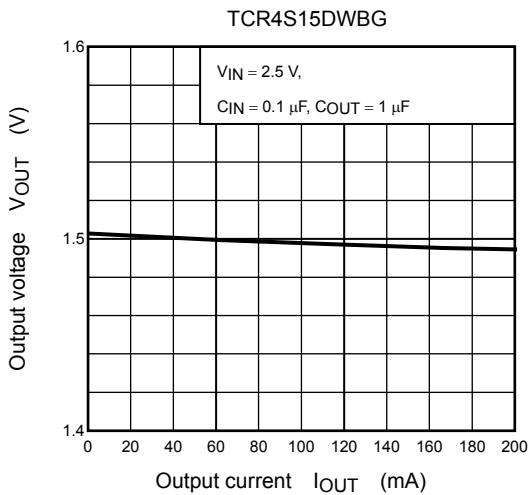

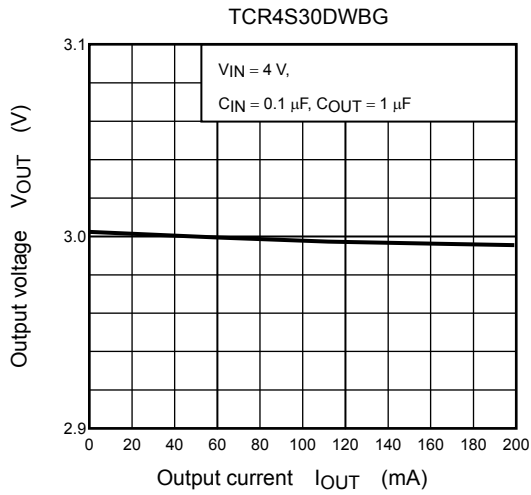

3) Output Voltage vs. Ambient temperature

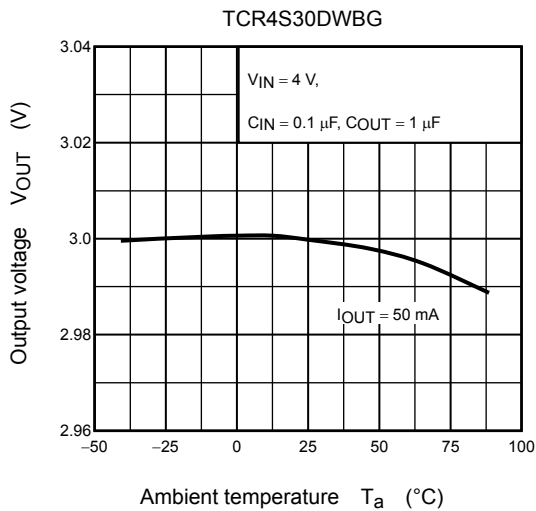
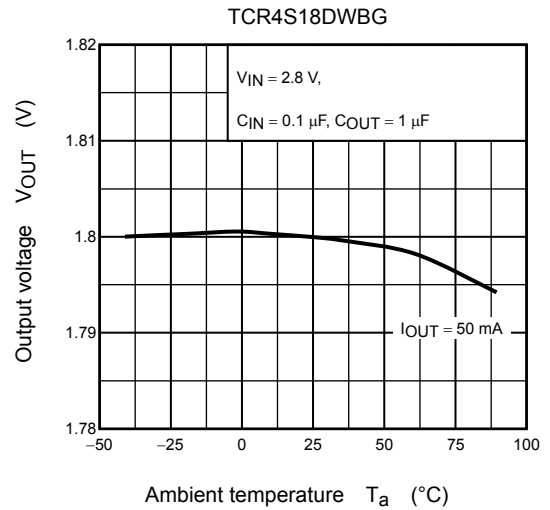
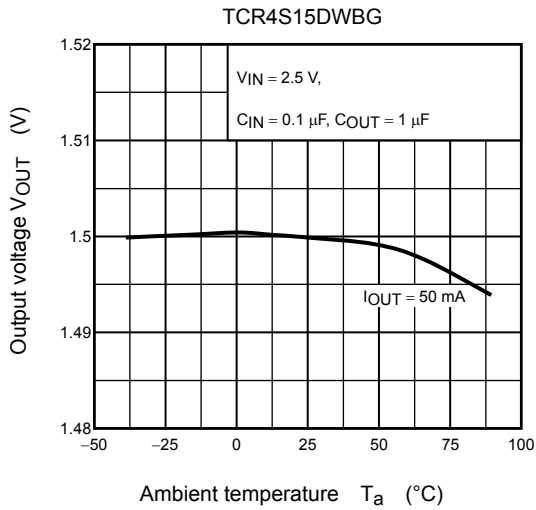

4) Dropout Voltage vs. Output Current

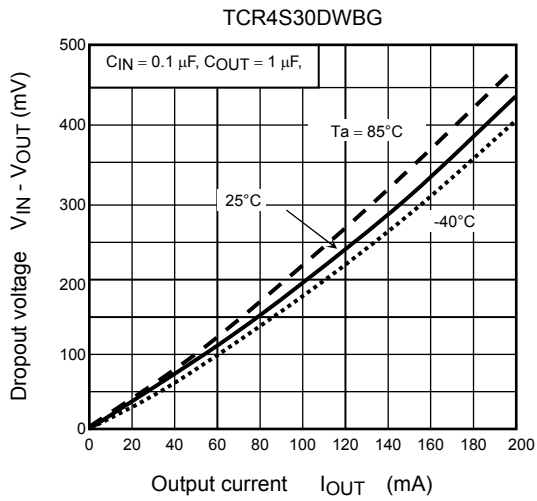

5) Quiescent Current vs. Input Voltage

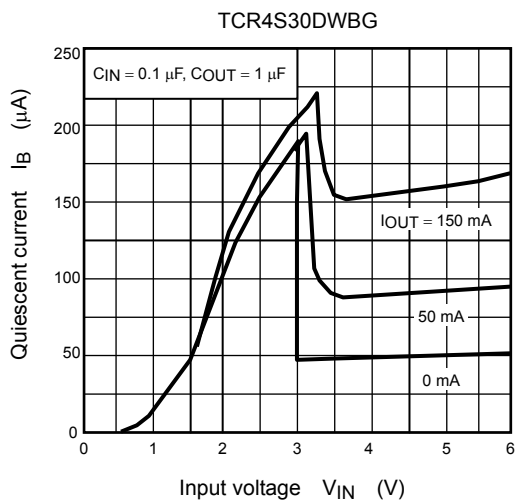
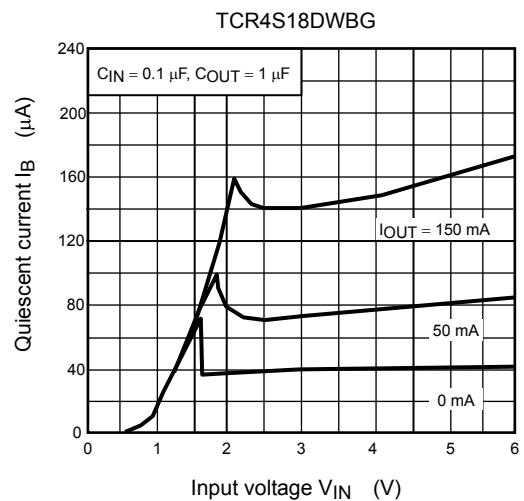
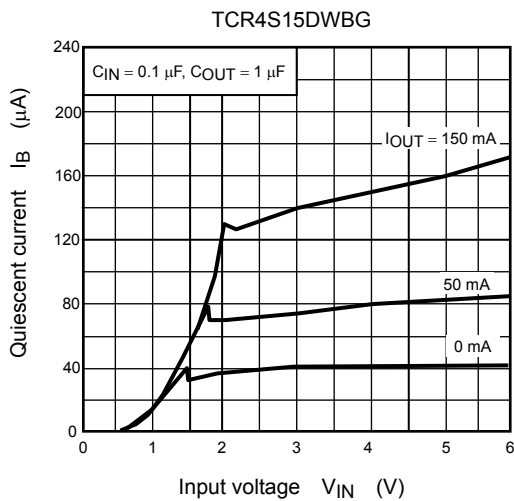

6) Quiescent current vs. Ambient temperature

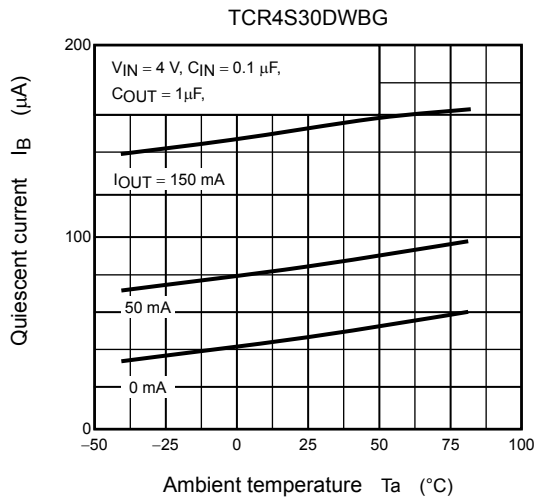
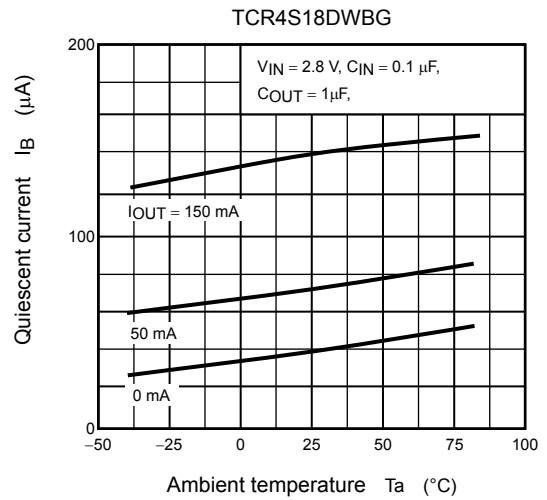
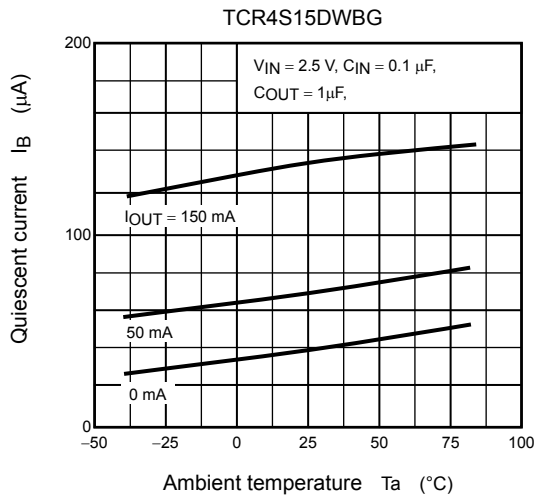

7) Overcurrent Protection Characteristics

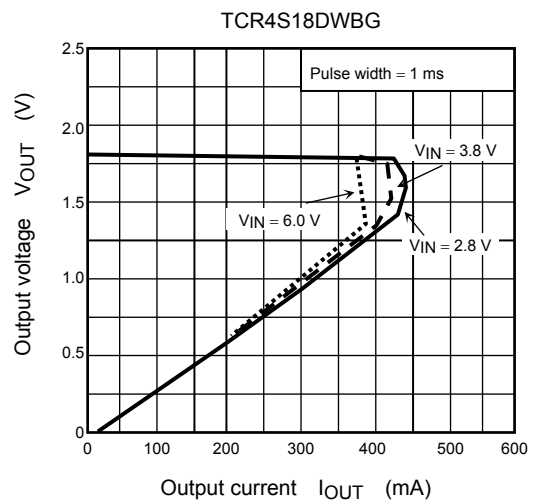
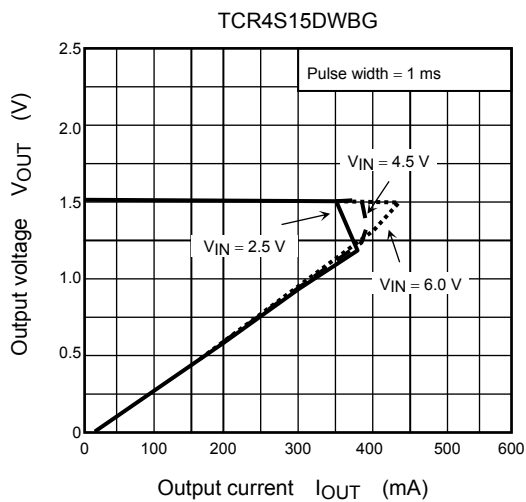

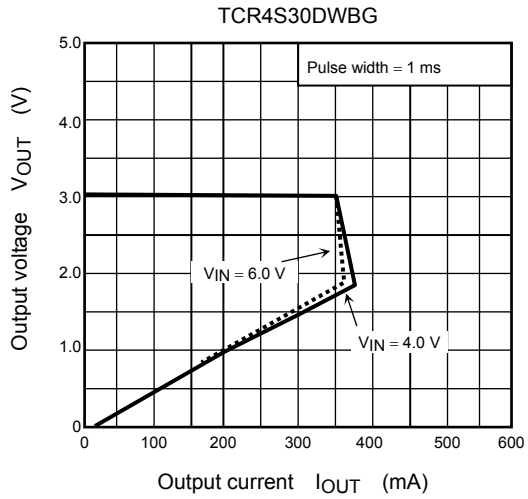

8) Ripple rejection Ratio vs. Frequency

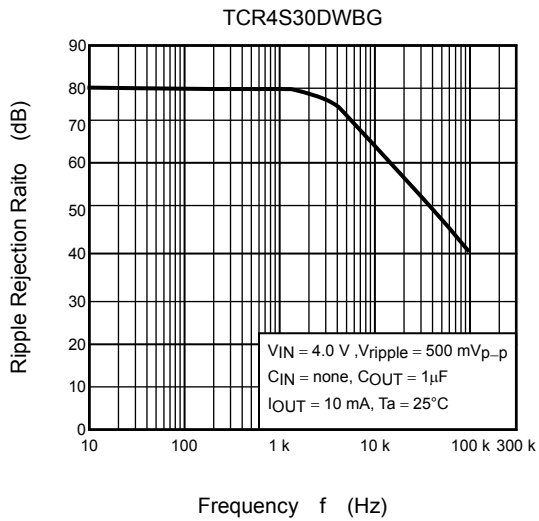

9) Control Transient Response (Auto-Discharge)

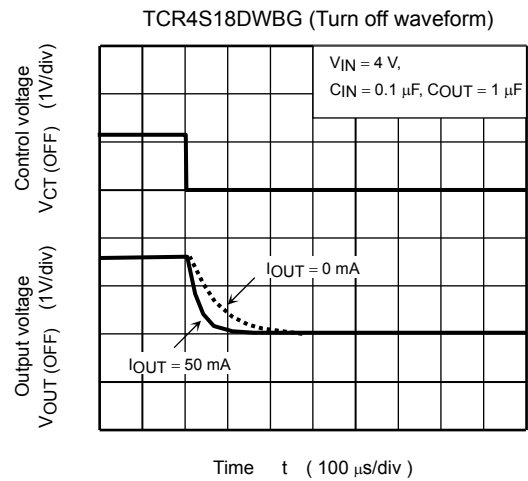
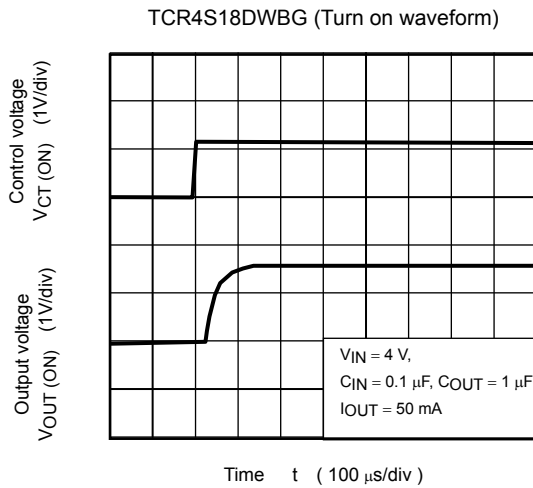

10) Load Transient Response

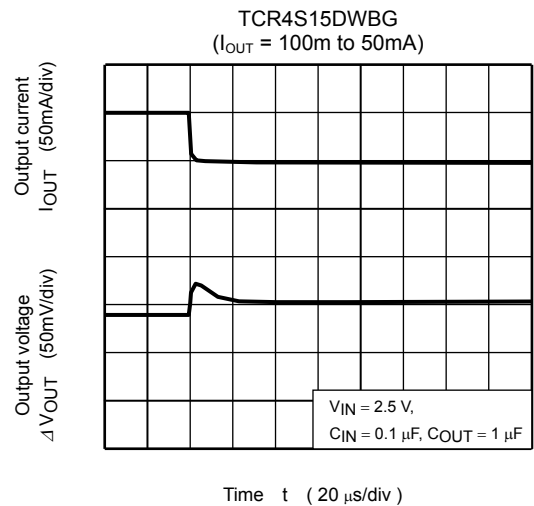
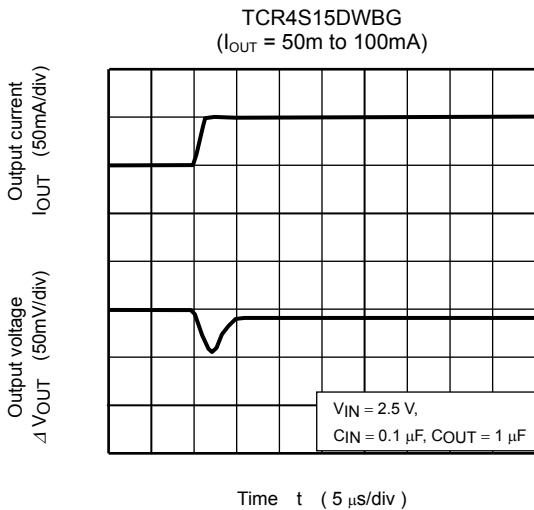
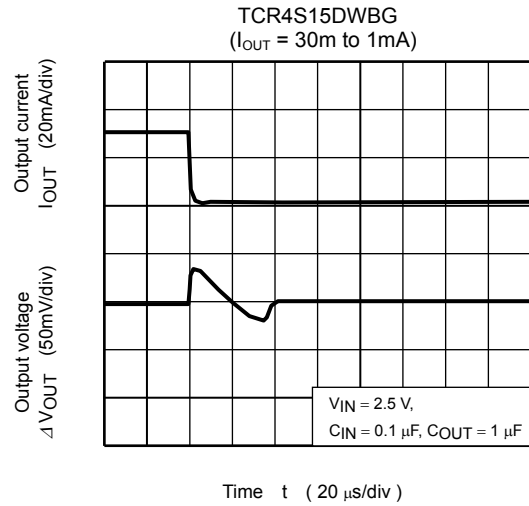
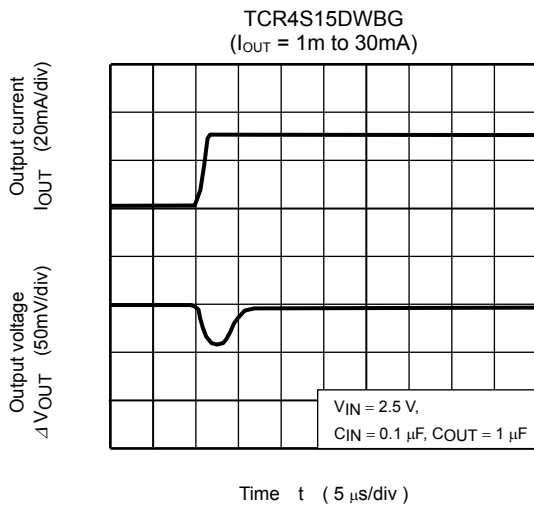

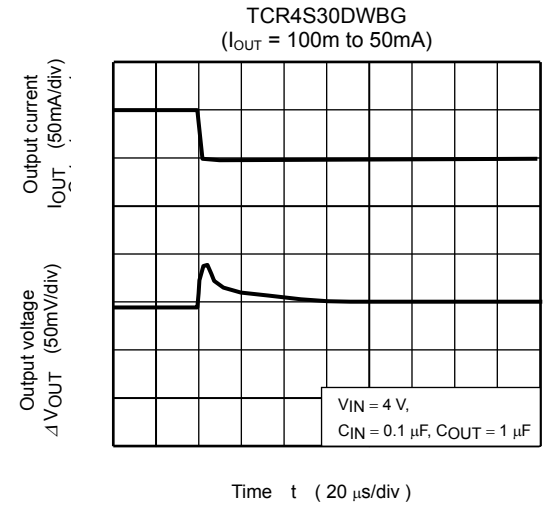
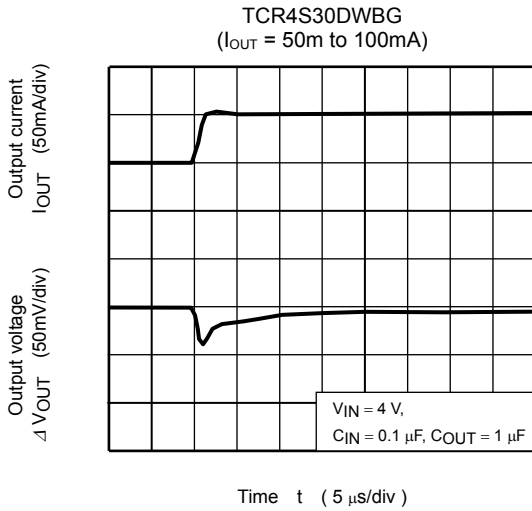
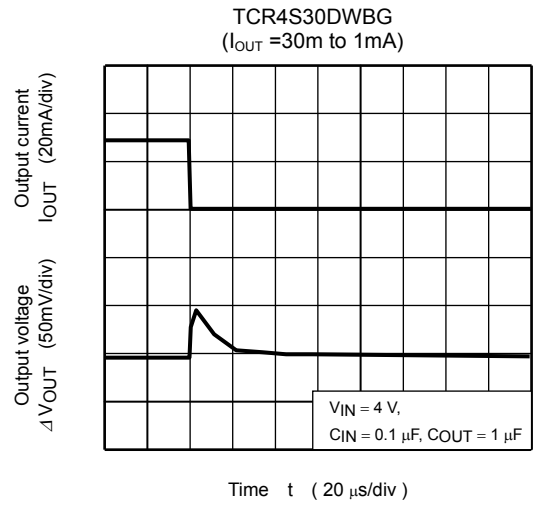
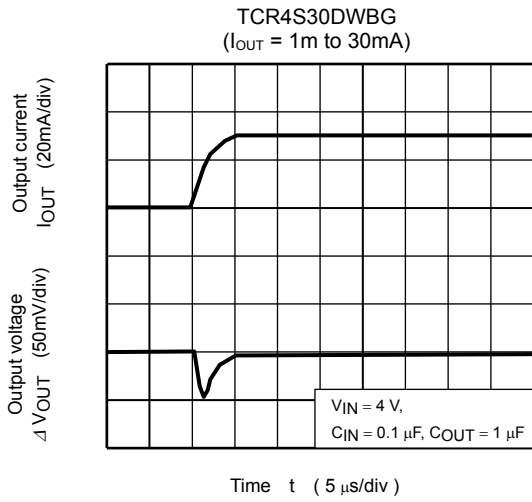

Package Dimensions

Unit: mm

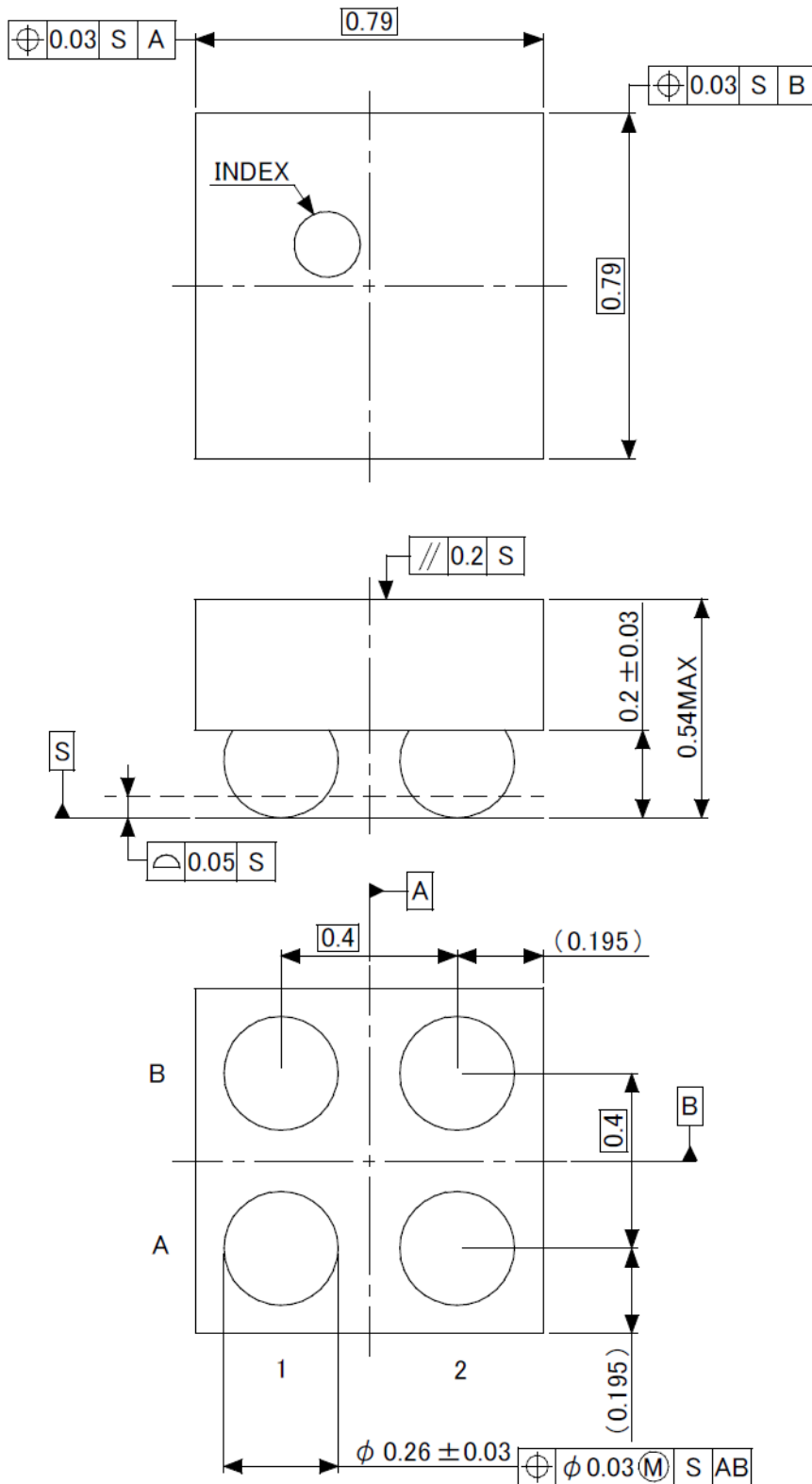

Weight: 0.7 mg (typ)

RESTRICTIONS ON PRODUCT USE

- Toshiba Corporation, and its subsidiaries and affiliates (collectively "TOSHIBA"), reserve the right to make changes to the information in this document, and related hardware, software and systems (collectively "Product") without notice.
- This document and any information herein may not be reproduced without prior written permission from TOSHIBA. Even with TOSHIBA's written permission, reproduction is permissible only if reproduction is without alteration/omission.
- Though TOSHIBA works continually to improve Product's quality and reliability, Product can malfunction or fail. Customers are responsible for complying with safety standards and for providing adequate designs and safeguards for their hardware, software and systems which minimize risk and avoid situations in which a malfunction or failure of Product could cause loss of human life, bodily injury or damage to property, including data loss or corruption. Before customers use the Product, create designs including the Product, or incorporate the Product into their own applications, customers must also refer to and comply with (a) the latest versions of all relevant TOSHIBA information, including without limitation, this document, the specifications, the data sheets and application notes for Product and the precautions and conditions set forth in the "TOSHIBA Semiconductor Reliability Handbook" and (b) the instructions for the application with which the Product will be used with or for. Customers are solely responsible for all aspects of their own product design or applications, including but not limited to (a) determining the appropriateness of the use of this Product in such design or applications; (b) evaluating and determining the applicability of any information contained in this document, or in charts, diagrams, programs, algorithms, sample application circuits, or any other referenced documents; and (c) validating all operating parameters for such designs and applications. **TOSHIBA ASSUMES NO LIABILITY FOR CUSTOMERS' PRODUCT DESIGN OR APPLICATIONS.**
- Product is intended for use in general electronics applications (e.g., computers, personal equipment, office equipment, measuring equipment, industrial robots and home electronics appliances) or for specific applications as expressly stated in this document. Product is neither intended nor warranted for use in equipment or systems that require extraordinarily high levels of quality and/or reliability and/or a malfunction or failure of which may cause loss of human life, bodily injury, serious property damage or serious public impact ("Unintended Use"). Unintended Use includes, without limitation, equipment used in nuclear facilities, equipment used in the aerospace industry, medical equipment, equipment used for automobiles, trains, ships and other transportation, traffic signaling equipment, equipment used to control combustions or explosions, safety devices, elevators and escalators, devices related to electric power, and equipment used in finance-related fields. Do not use Product for Unintended Use unless specifically permitted in this document.
- Do not disassemble, analyze, reverse-engineer, alter, modify, translate or copy Product, whether in whole or in part.
- Product shall not be used for or incorporated into any products or systems whose manufacture, use, or sale is prohibited under any applicable laws or regulations.
- The information contained herein is presented only as guidance for Product use. No responsibility is assumed by TOSHIBA for any infringement of patents or any other intellectual property rights of third parties that may result from the use of Product. No license to any intellectual property right is granted by this document, whether express or implied, by estoppel or otherwise.
- **ABSENT A WRITTEN SIGNED AGREEMENT, EXCEPT AS PROVIDED IN THE RELEVANT TERMS AND CONDITIONS OF SALE FOR PRODUCT, AND TO THE MAXIMUM EXTENT ALLOWABLE BY LAW, TOSHIBA (1) ASSUMES NO LIABILITY WHATSOEVER, INCLUDING WITHOUT LIMITATION, INDIRECT, CONSEQUENTIAL, SPECIAL, OR INCIDENTAL DAMAGES OR LOSS, INCLUDING WITHOUT LIMITATION, LOSS OF PROFITS, LOSS OF OPPORTUNITIES, BUSINESS INTERRUPTION AND LOSS OF DATA, AND (2) DISCLAIMS ANY AND ALL EXPRESS OR IMPLIED WARRANTIES AND CONDITIONS RELATED TO SALE, USE OF PRODUCT, OR INFORMATION, INCLUDING WARRANTIES OR CONDITIONS OF MERCHANTABILITY, FITNESS FOR A PARTICULAR PURPOSE, ACCURACY OF INFORMATION, OR NONINFRINGEMENT.**
- Do not use or otherwise make available Product or related software or technology for any military purposes, including without limitation, for the design, development, use, stockpiling or manufacturing of nuclear, chemical, or biological weapons or missile technology products (mass destruction weapons). Product and related software and technology may be controlled under the Japanese Foreign Exchange and Foreign Trade Law and the U.S. Export Administration Regulations. Export and re-export of Product or related software or technology are strictly prohibited except in compliance with all applicable export laws and regulations.
- Please contact your TOSHIBA sales representative for details as to environmental matters such as the RoHS compatibility of Product. Please use Product in compliance with all applicable laws and regulations that regulate the inclusion or use of controlled substances, including without limitation, the EU RoHS Directive. TOSHIBA assumes no liability for damages or losses occurring as a result of noncompliance with applicable laws and regulations.