

TENTATIVE TOSHIBA CMOS DIGITAL INTEGRATED CIRCUIT SILICON MONOLITHIC

# TC7W34FU, TC7W34FK

(UNDER DEVELOPMENT)

## TRIPLE NON-INVERT BUFFER

The TC7W34FU is high speed CMOS BUFFER fabricated with silicon gate CMOS technology.

The internal circuit is composed of 2 stage including buffer output, which enable high noise immunity and stable output.

All inputs are equipped with protection circuits against static discharge or transient excess voltage.

### FEATURES

- High Speed .....  $t_{pd} = 6ns$  (Typ.) at  $V_{CC} = 5V$
- Low Power Dissipation .....  $I_{CC} = 1\mu A$  (Max.) at  $T_a = 25^\circ C$
- High Noise Immunity .....  $V_{NIH} = V_{NIL} = 28\% V_{CC}$  (Min.)
- Output Drive Capability ..... 10 LSTTL Loads
- Symmetrical Output Impedance...  $|I_{OH}| = |I_{OL}| = 4mA$  (Min.)
- Balanced Propagation Delays.....  $t_{pLH} = t_{pHL}$
- Wide Operating Voltage Range...  $V_{CC} (opr) = 2\sim 6V$

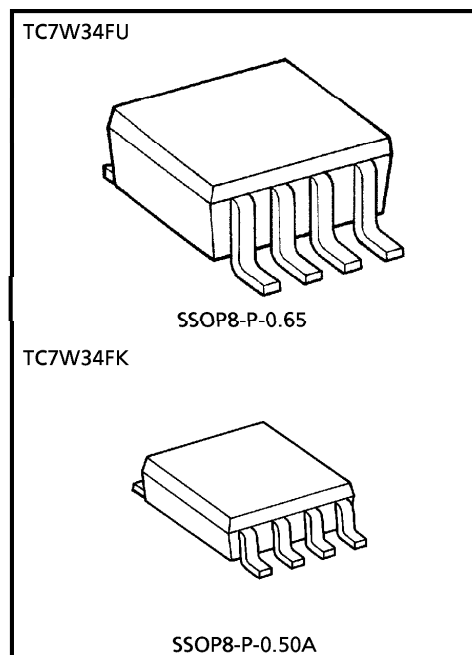

Weight  
 SSOP8-P-0.65 : 0.02g (Typ.)  
 SSOP8-P-0.50A : 0.01g (Typ.)

### MARKING

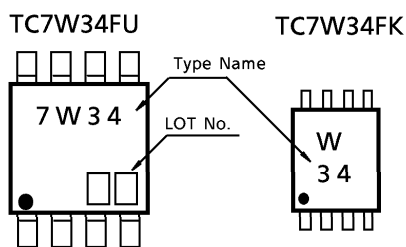

### TRUTH TABLE

A	Y
L	L
H	H

980910EBA1

- TOSHIBA is continually working to improve the quality and the reliability of its products. Nevertheless, semiconductor devices in general can malfunction or fail due to their inherent electrical sensitivity and vulnerability to physical stress. It is the responsibility of the buyer, when utilizing TOSHIBA products, to observe standards of safety, and to avoid situations in which a malfunction or failure of a TOSHIBA product could cause loss of human life, bodily injury or damage to property. In developing your designs, please ensure that TOSHIBA products are used within specified operating ranges as set forth in the most recent products specifications. Also, please keep in mind the precautions and conditions set forth in the TOSHIBA Semiconductor Reliability Handbook.
- The products described in this document are subject to the foreign exchange and foreign trade laws.
- The information contained herein is presented only as a guide for the applications of our products. No responsibility is assumed by TOSHIBA CORPORATION for any infringements of intellectual property or other rights of the third parties which may result from its use. No license is granted by implication or otherwise under any intellectual property or other rights of TOSHIBA CORPORATION or others.
- The information contained herein is subject to change without notice.

**MAXIMUM RATINGS (Ta = 25°C)**

CHARACTERISTIC	SYMBOL	RATING	UNIT
Supply Voltage Range	V <sub>CC</sub>	- 0.5~7	V
DC Input Voltage	V <sub>IN</sub>	- 0.5~V <sub>CC</sub> + 0.5	V
DC Output Voltage	V <sub>OUT</sub>	- 0.5~V <sub>CC</sub> + 0.5	V
Input Diode Current	I <sub>IK</sub>	± 20	mA
Output Diode Current	I <sub>OK</sub>	± 20	mA
DC Output Current	I <sub>OUT</sub>	± 25	mA
DC V <sub>CC</sub> / Ground Current	I <sub>CC</sub>	± 25	mA
Power Dissipation	P <sub>D</sub>	300	mW
Storage Temperature	T <sub>stg</sub>	- 65~150	°C
Lead Temperature (10 s)	T <sub>L</sub>	260	°C

**LOGIC DIAGRAM**

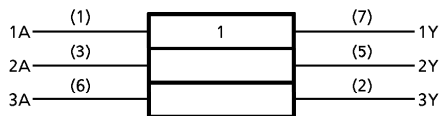

**PIN ASSIGNMENT (TOP VIEW)**

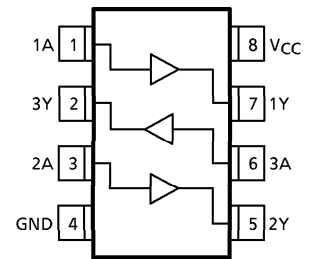

**RECOMMENDED OPERATING CONDITIONS**

CHARACTERISTIC	SYMBOL	RATING	UNIT
Supply Voltage Range	V <sub>CC</sub>	2~6	V
Input Voltage	V <sub>IN</sub>	0~V <sub>CC</sub>	V
Output Voltage	V <sub>OUT</sub>	0~V <sub>CC</sub>	V
Operating Temperature	T <sub>opr</sub>	- 40~85	°C
Input Rise and Fall Time	t <sub>r</sub> , t <sub>f</sub>	0~1000 (V <sub>CC</sub> = 2.0V)	ns
		0~500 (V <sub>CC</sub> = 4.5V)	
		0~400 (V <sub>CC</sub> = 6.0V)	

**DC ELECTRICAL CHARACTERISTICS**

CHARACTERISTIC	SYMBOL	TEST CONDITION		Ta = 25°C			Ta = -40~85°C		UNIT	
				V <sub>CC</sub>	MIN.	TYP.	MAX.	MIN.		MAX.
High-Level Input Voltage	V <sub>IH</sub>			2.0	1.5	—	—	1.5	—	V
				4.5	3.15	—	—	3.15	—	
				6.0	4.2	—	—	4.2	—	
Low-Level Input Voltage	V <sub>IL</sub>			2.0	—	—	0.5	—	0.5	V
				4.5	—	—	1.35	—	1.35	
				6.0	—	—	1.8	—	1.8	
High-Level Output Voltage	V <sub>OH</sub>	V <sub>IN</sub> = V <sub>IH</sub>	I <sub>OH</sub> = -20μA	2.0	1.9	2.0	—	1.9	—	V
				4.5	4.4	4.5	—	4.4	—	
				6.0	5.9	6.0	—	5.9	—	
				I <sub>OH</sub> = -4mA	4.5	4.18	4.31	—	4.13	
I <sub>OH</sub> = -5.2mA	6.0	5.68	5.80	—	5.63	—				
Low-Level Output Voltage	V <sub>OL</sub>	V <sub>IN</sub> = V <sub>IL</sub>	I <sub>OL</sub> = 20μA	2.0	—	0.0	0.1	—	0.1	V
				4.5	—	0.0	0.1	—	0.1	
				6.0	—	0.0	0.1	—	0.1	
				I <sub>OL</sub> = 4mA	4.5	—	0.17	0.26	—	
I <sub>OL</sub> = 5.2mA	6.0	—	0.18	0.26	—	0.33				
Input Leakage Current	I <sub>IN</sub>	V <sub>IN</sub> = V <sub>CC</sub> or GND		6.0	—	—	±0.1	—	±1.0	μA
Quiescent Supply Current	I <sub>CC</sub>	V <sub>IN</sub> = V <sub>CC</sub> or GND		6.0	—	—	1.0	—	10.0	μA

**AC ELECTRICAL CHARACTERISTICS (C<sub>L</sub> = 15pF, V<sub>CC</sub> = 5V, Ta = 25°C)**

CHARACTERISTIC	SYMBOL	TEST CONDITION	Ta = 25°C			UNIT
			MIN.	TYP.	MAX.	
Output Transition Time	t <sub>TLH</sub> t <sub>THL</sub>	—	—	4	8	ns
Propagation Delay Time	t <sub>pLH</sub> t <sub>pHL</sub>	—	—	6	12	ns

**AC ELECTRICAL CHARACTERISTICS (C<sub>L</sub> = 50pF, Input t<sub>r</sub> = t<sub>f</sub> = 6ns)**

CHARACTERISTIC	SYMBOL	TEST CONDITION		Ta = 25°C			Ta = -40~85°C		UNIT	
				V <sub>CC</sub>	MIN.	TYP.	MAX.	MIN.		MAX.
Output Transition Time	t <sub>TLH</sub> t <sub>THL</sub>	—		2.0	—	30	75	—	95	ns
				4.5	—	8	15	—	19	
				6.0	—	7	13	—	16	
Propagation Delay Time	t <sub>pLH</sub> t <sub>pHL</sub>	—		2.0	—	27	75	—	95	ns
				4.5	—	9	15	—	19	
				6.0	—	8	13	—	16	
Input Capacitance	C <sub>IN</sub>	—		—	5	10	—	10	pF	
Power Dissipation Capacitance	C <sub>PD</sub>	(Note 1)		—	20	—	—	—	pF	

(Note 1) : C<sub>PD</sub> is defined as the value of the internal equivalent capacitance of IC which is calculated from the operating current consumption without load.

Average operating current can be obtained by the equation hereunder.

$$I_{CC(opr)} = C_{PD} \cdot V_{CC} \cdot f_{IN} + I_{CC} / 3 \text{ (per gate)}$$

SWITCHING CHARACTERISTICS TEST CIRCUIT

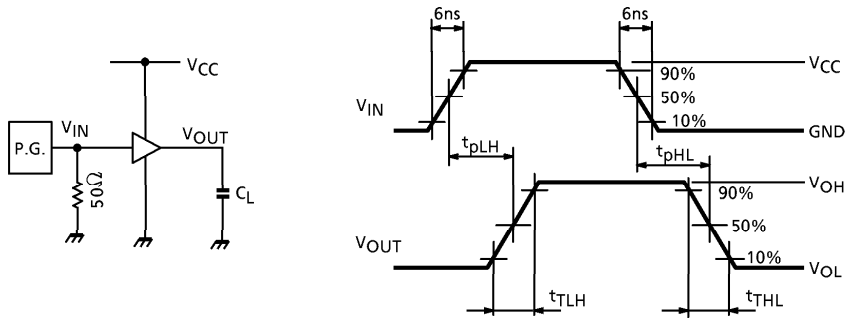

**OUTLINE DRAWING**  
SSOP8-P-0.65

Unit : mm

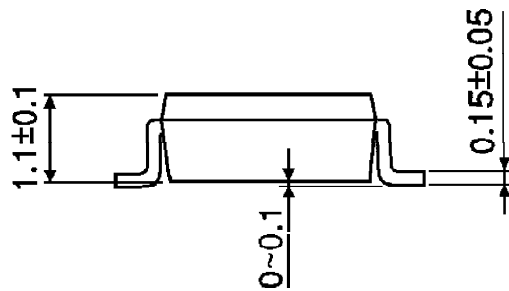
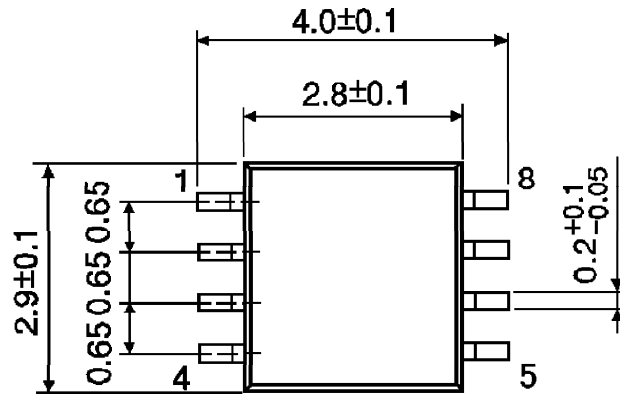

Weight : 0.02g (Typ.)

OUTLINE DRAWING  
SSOP8-P-0.50A

Unit : mm

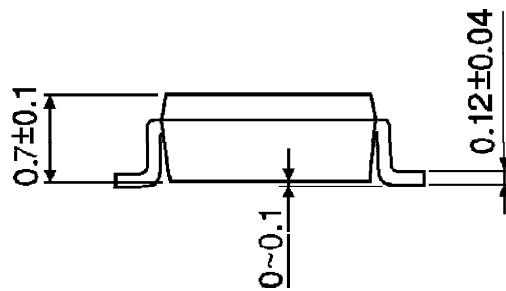
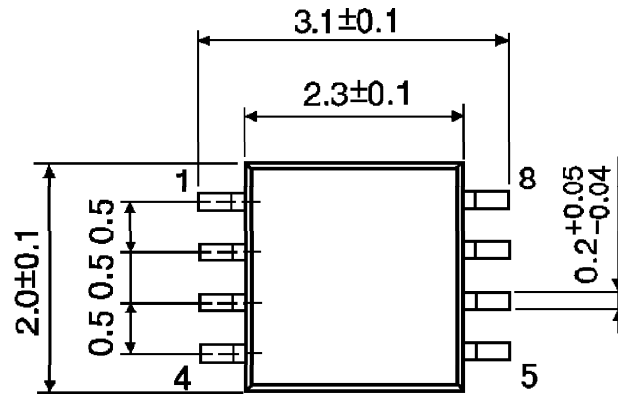

Weight : 0.01g (Typ.)