

TN6729A

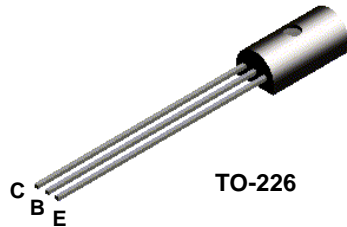

TO-226

NZT6729

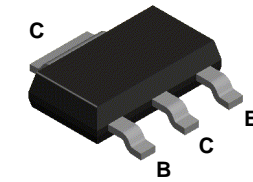

SOT-223

PNP General Purpose Amplifier

This device is designed for general purpose medium power amplifiers and switches requiring collector currents to 800 mA. Sourced from Process 79.

Absolute Maximum Ratings*

TA = 25°C unless otherwise noted

Symbol	Parameter	Value	Units
V _{CEO}	Collector-Emitter Voltage	80	V
V _{CBO}	Collector-Base Voltage	80	V
V _{EBO}	Emitter-Base Voltage	5.0	V
I _C	Collector Current - Continuous	1.0	A
T _J , T _{stg}	Operating and Storage Junction Temperature Range	-55 to +150	°C

*These ratings are limiting values above which the serviceability of any semiconductor device may be impaired.

NOTES:

- 1) These ratings are based on a maximum junction temperature of 150 degrees C.
- 2) These are steady state limits. The factory should be consulted on applications involving pulsed or low duty cycle operations.

Thermal Characteristics

TA = 25°C unless otherwise noted

Symbol	Characteristic	Max		Units
		TN6729A	*NZT6729	
P _D	Total Device Dissipation Derate above 25°C	1.0	1.0	W
		8.0	8.0	mW/°C
R _{θJC}	Thermal Resistance, Junction to Case	50		°C/W
R _{θJA}	Thermal Resistance, Junction to Ambient	125	125	°C/W

*Device mounted on FR-4 PCB 36 mm X 18 mm X 1.5 mm; mounting pad for the collector lead min. 6 cm².

PNP General Purpose Amplifier

(continued)

TN6729A / NZT6729

Electrical Characteristics

TA = 25°C unless otherwise noted

Symbol	Parameter	Test Conditions	Min	Max	Units
OFF CHARACTERISTICS					
$V_{(BR)CEO}$	Collector-Emitter Breakdown Voltage	$I_C = 1.0 \text{ mA}, I_B = 0$	80		V
$V_{(BR)CBO}$	Collector-Base Breakdown Voltage	$I_C = 100 \text{ } \mu\text{A}, I_E = 0$	80		V
$V_{(BR)EBO}$	Emitter-Base Breakdown Voltage	$I_E = 1.0 \text{ mA}, I_C = 0$	5.0		V
I_{CBO}	Collector-Cutoff Current	$V_{CB} = 60 \text{ V}, I_E = 0$		0.1	μA
I_{EBO}	Emitter-Cutoff Current	$V_{EB} = 5.0 \text{ V}, I_C = 0$		10	μA

ON CHARACTERISTICS*

h_{FE}	DC Current Gain	$I_C = 50 \text{ mA}, V_{CE} = 1.0 \text{ V}$ $I_C = 250 \text{ mA}, V_{CE} = 1.0 \text{ V}$ $I_C = 500 \text{ mA}, V_{CE} = 1.0 \text{ V}$	80 50 20	250	
$V_{CE(sat)}$	Collector-Emitter Saturation Voltage	$I_C = 250 \text{ mA}, I_B = 10 \text{ mA}$ $I_C = 250 \text{ mA}, I_B = 25 \text{ mA}$		0.5 0.35	V
$V_{BE(on)}$	Base-Emitter On Voltage	$I_C = 250 \text{ mA}, V_{CE} = 1.0 \text{ V}$		1.2	V

SMALL SIGNAL CHARACTERISTICS

h_{fe}	Small-Signal Current Gain	$I_C = 200 \text{ mA}, V_{CE} = 5.0 \text{ V},$ $f = 20 \text{ MHz}$	2.5	25	
C_{cb}	Collector-Base Capacitance	$V_{CB} = 10 \text{ V}, I_E = 0, f = 1.0 \text{ MHz}$		30	pF

*Pulse Test: Pulse Width $\leq 300 \text{ } \mu\text{s}$, Duty Cycle $\leq 1.0\%$

Typical Characteristics

Typical Pulsed Current Gain vs Collector Current

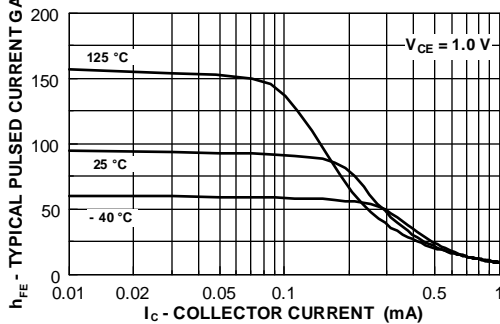

Collector-Emitter Saturation Voltage vs Collector Current

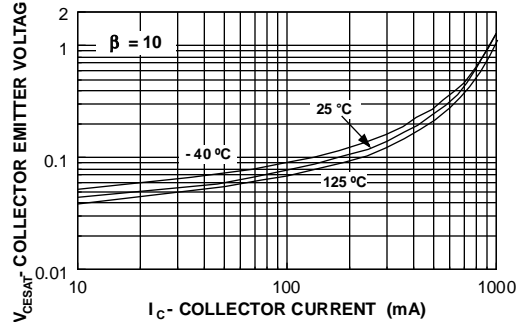

Typical Characteristics (continued)

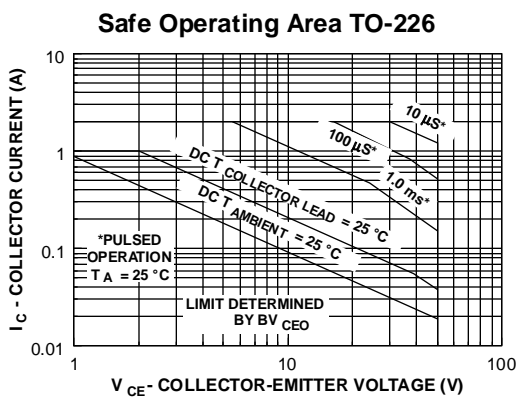
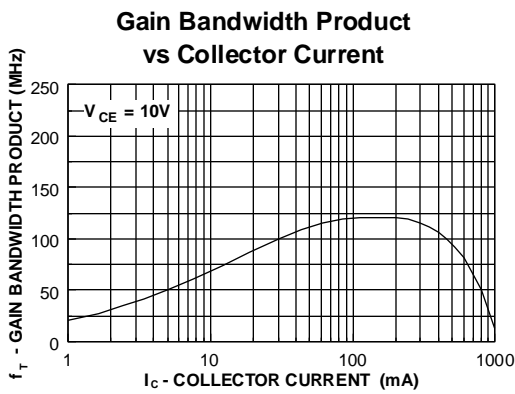
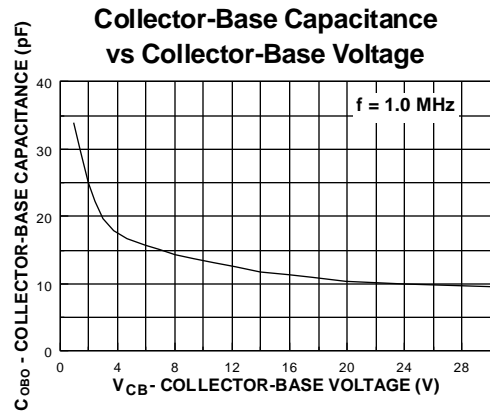
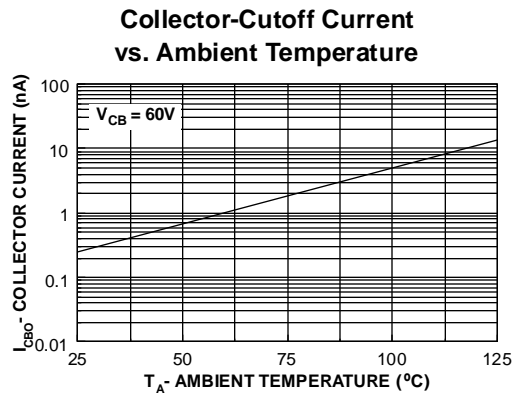
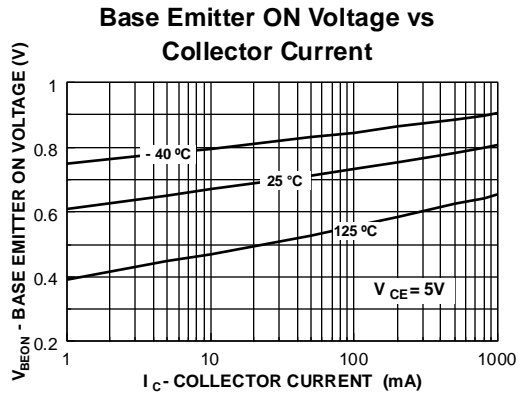
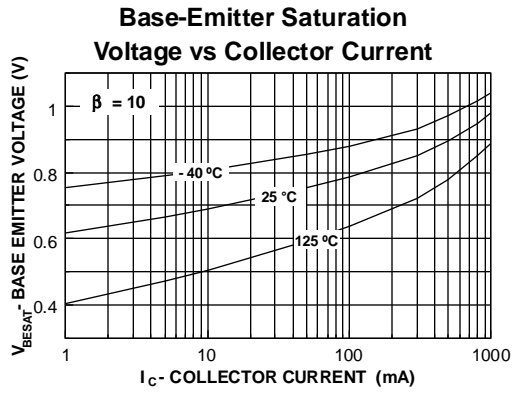

Typical Characteristics (continued)

