

### 5 TERMINAL LOW DROP VOLTAGE REGULATOR

The KIA78R × × Series are Low Drop Voltage Regulator suitable for various electronic equipments. It provides constant voltage power source with DPAK-5 terminal surface mount type PKG.

The Regulator has multi function such as over current protection, overheat protection and ON/OFF control.

#### FEATURES

- 1.0A Output Low Drop Voltage Regulator.
- Built in ON/OFF Control Terminal.
- Built in Over Current Protection, Over Heat Protection Function.

#### LINE UP

ITEM	OUTPUT VOLTAGE (Typ.)	UNIT
KIA78R05F	5	V
KIA78R06F	6	
KIA78R08F	8	
KIA78R09F	9	
KIA78R10F	10	
KIA78R12F	12	
KIA78R15F	15	

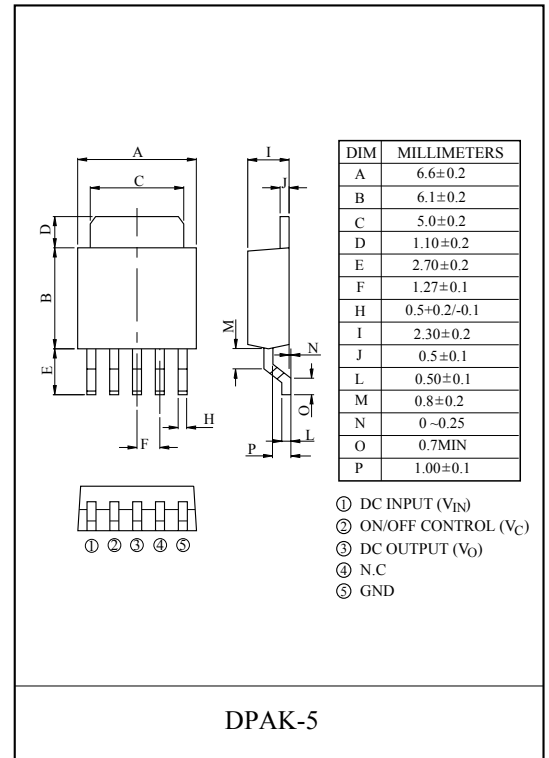

#### MAXIMUM RATINGS (Ta=25 °C)

CHARACTERISTIC	SYMBOL	RATING	UNIT	REMARK
Input Voltage	V <sub>IN</sub>	35	V	-
ON/OFF Control Voltage	V <sub>C</sub>	35	V	-
Output Current	I <sub>O</sub>	1	A	-
Power Dissipation 1	P <sub>d</sub>	8	W	Infinite heat sink
Junction Temperature	T <sub>j</sub>	125	°C	-
Operating Temperature	T <sub>opr</sub>	-20 ~ 80	°C	-
Storage Temperature	T <sub>stg</sub>	-30 ~ 125	°C	-
Soldering Temperature (10sec)	T <sub>sol</sub>	260	°C	-

# KIA78R05F~KIA78R15F

## ELECTRICAL CHARACTERISTICS

(Unless otherwise specified,  $I_O=0.5A$ ,  $T_a=25^\circ C$ , Note1.)

CHARACTERISTIC		SYMBOL	CONDITIONS	MIN.	TYP.	MAX.	UNIT
Output Voltage	KIA78R05	$V_O$	-	4.88	5.0	5.12	V
	KIA78R06		-	5.85	6.0	6.15	
	KIA78R08		-	7.80	8.0	8.2	
	KIA78R09		-	8.78	9.0	9.22	
	KIA78R10		-	9.75	10.0	10.25	
	KIA78R12		-	11.70	12.0	12.30	
	KIA78R15		-	14.70	15.0	15.30	
Load Regulation	Reg Load	$I_O=5mA \sim 1A$	-	0.1	2.0	%	
Line Regulation	Reg Line	(Note 2)	-	0.5	2.5	%	
Ripple Rejection	R · R		45	55	-	dB	
Drop Out Voltage	$V_D$	(Note 3)	-	-	0.5	V	
Output ON state for control Voltage	$V_{C(ON)}$		2.0	-	-	V	
Output ON state for control Current	$I_{C(ON)}$	$V_C=2.7V$	-	-	20	$\mu A$	
Output OFF state for control Voltage	$V_{C(OFF)}$	-	-	-	0.8	V	
Output OFF state for control Current	$I_{C(OFF)}$	$V_C=0.4V$	-	-	-0.4	mA	
Quiescent Current	$I_Q$	$I_O=0$	-	-	10	mA	

Note1)  $V_{IN}$  of KIA78R05=7V

- " KIA78R06=8V
- " KIA78R08=10V
- " KIA78R09=15V
- " KIA78R10=16V
- " KIA78R12=18V
- " KIA78R15=21V

Note2)  $V_{IN}$  of KIA78R05=6 ~ 12V

- " KIA78R06=7 ~ 15V
- " KIA78R08=9 ~ 25V
- " KIA78R09=10 ~ 25V
- " KIA78R10=11 ~ 26V
- " KIA78R12=13 ~ 29V
- " KIA78R15=16 ~ 32V

Note3) At  $V_{IN}=0.95V_O$

## BLOCK DIAGRAM

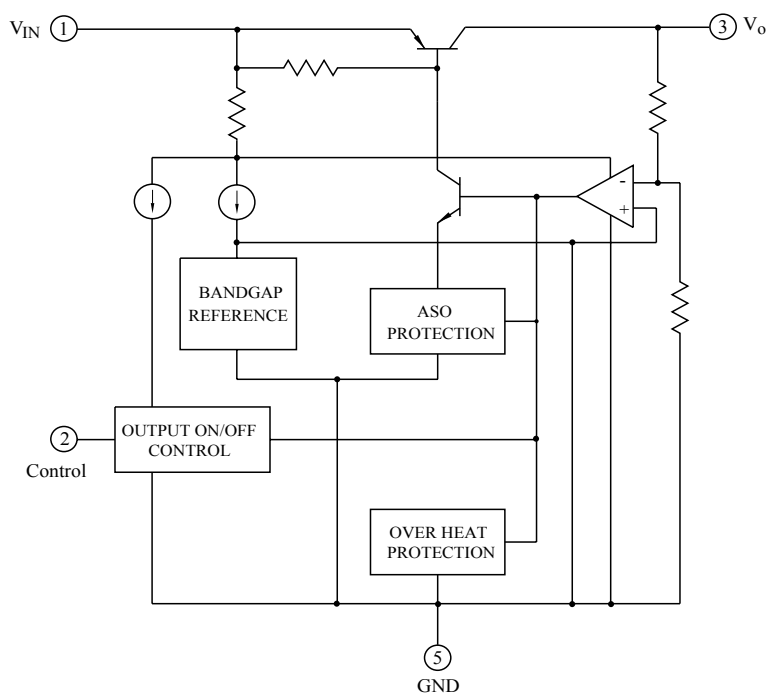

# KIA78R05F~KIA78R15F

Fig. 1 Standard Test Circuit

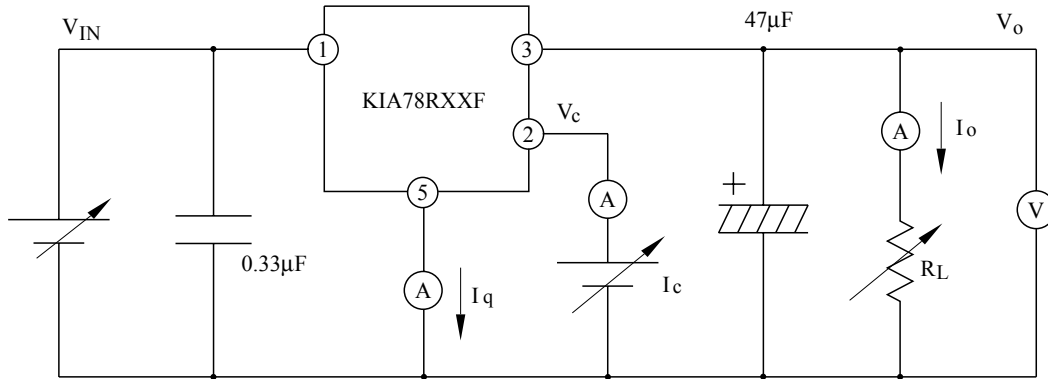

Fig. 1-2 Ripple Rejection Test Circuit

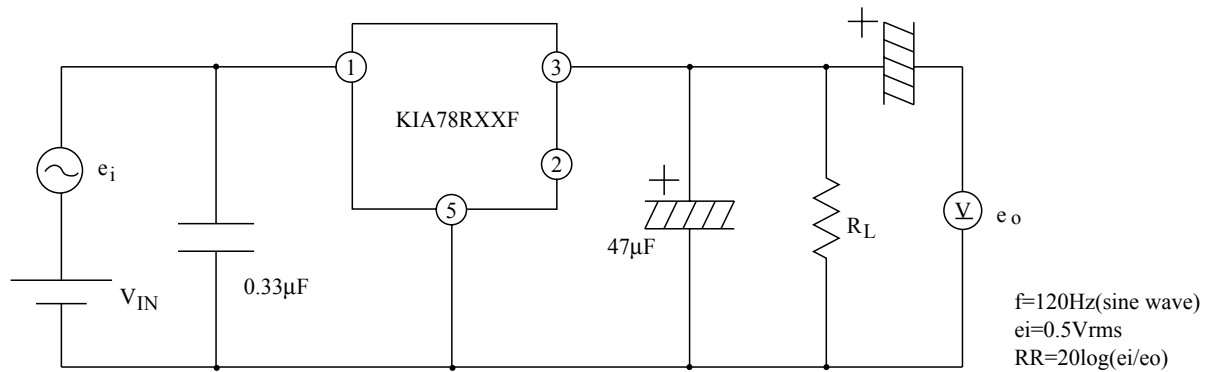
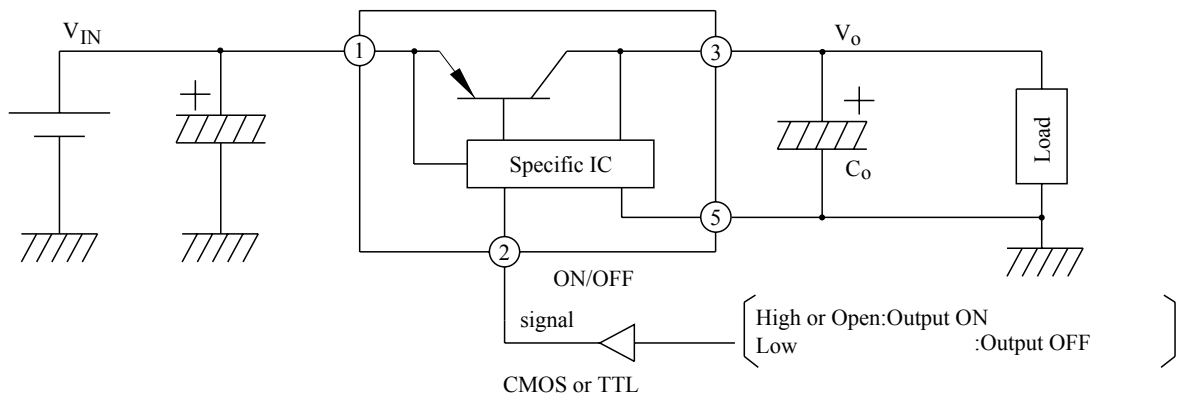
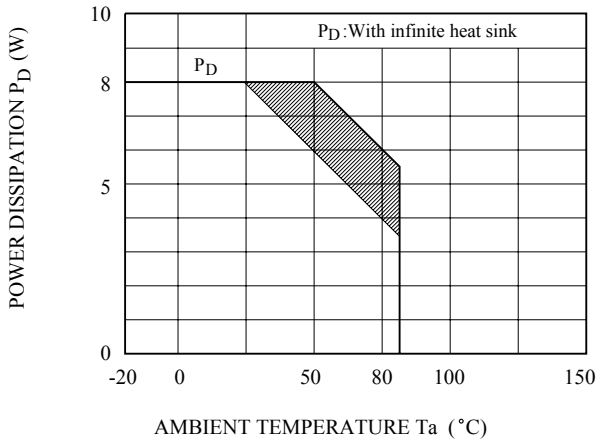

Fig. 2 Application Circuit for Standard



# KIA78R05F~KIA78R15F

Fig.3  $T_a - P_D$



Note) Oblique line portion : Overheat protection may operate in this area.

Fig.4  $I_O - V_O$

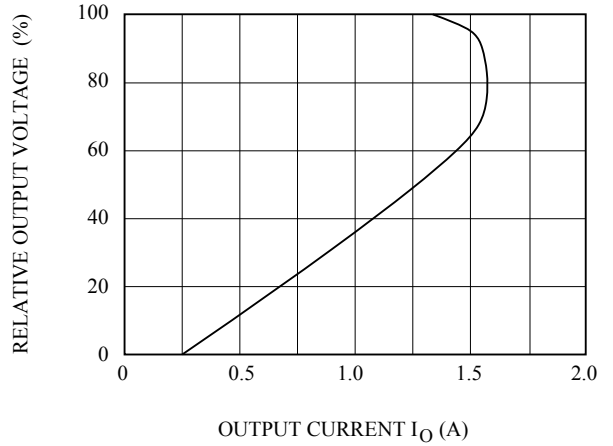

Fig.5-1  $T_j - \Delta V_O$  (KIA78R05)

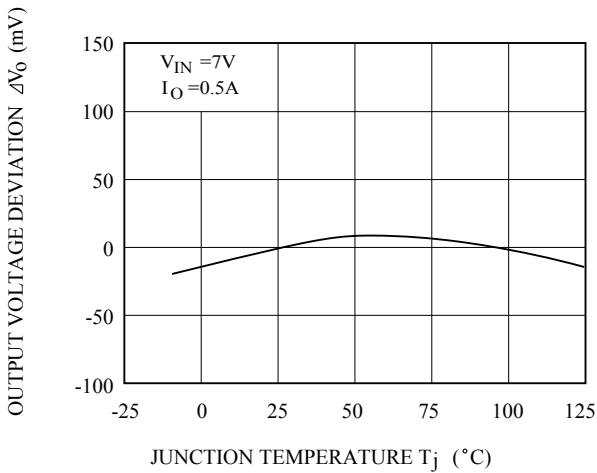

Fig.5-2  $T_j - \Delta V_O$  (KIA78R06)

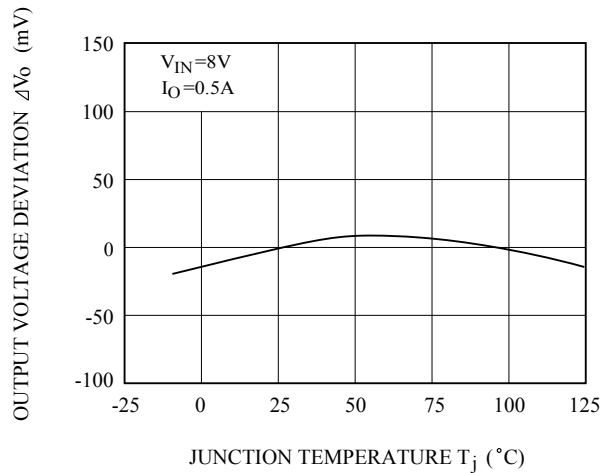

Fig.5-3  $T_j - \Delta V_O$  (KIA78R08)

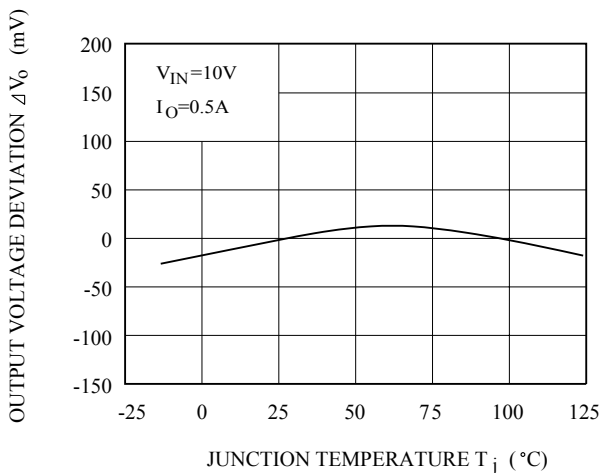
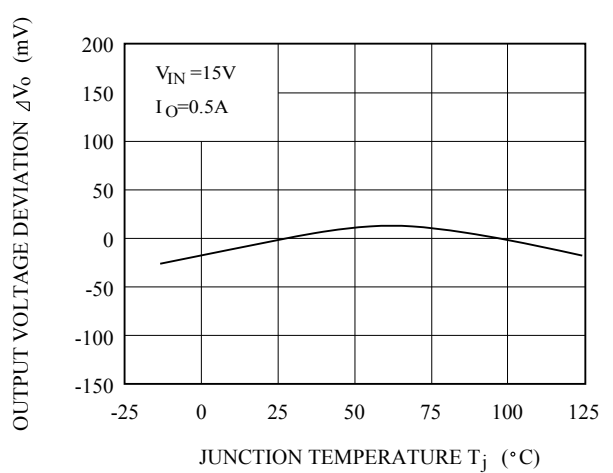

Fig.5-4  $T_j - \Delta V_O$  (KIA78R09)



# KIA78R05F~KIA78R15F

Fig.5-5  $T_j - \Delta V_o$  (KIA78R10)

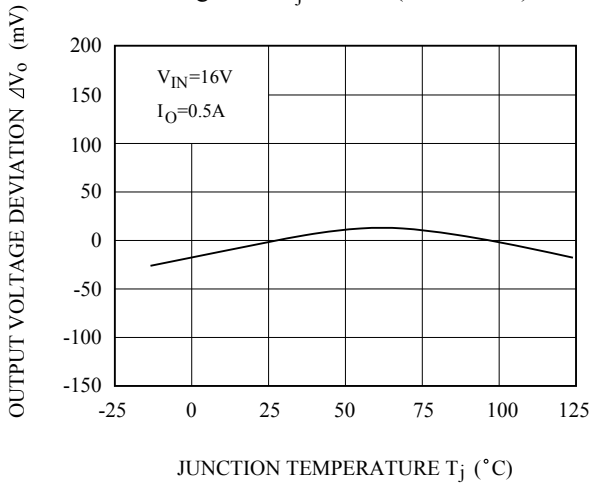

Fig.5-6  $T_j - \Delta V_o$  (KIA78R12)

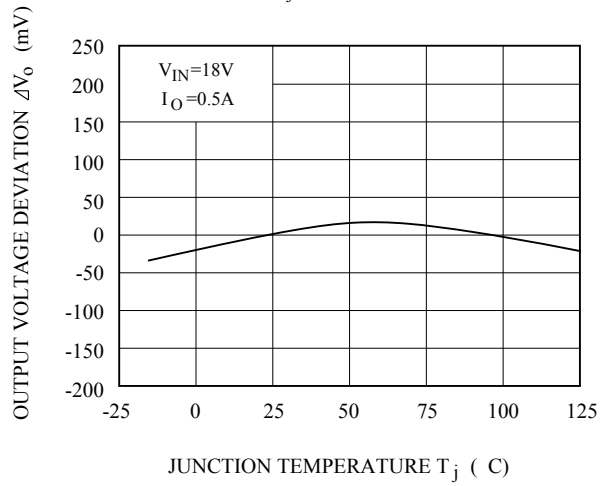

Fig.5-7  $T_j - \Delta V_o$  (KIA78R15)

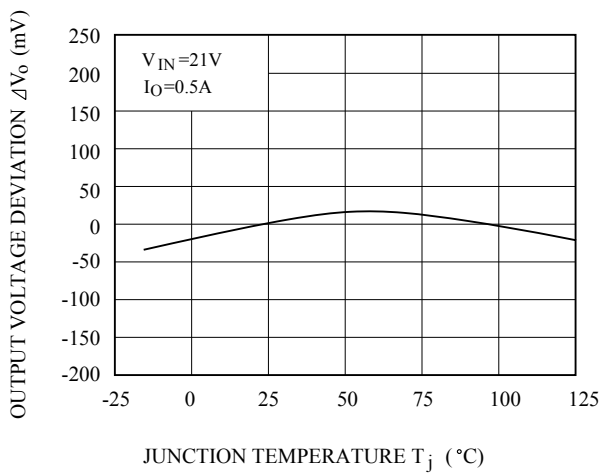

Fig.6-1  $V_{IN} - V_o$  (KIA78R05)

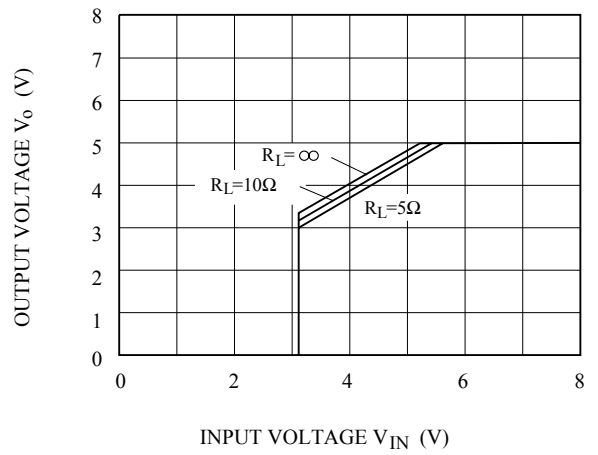

Fig.6-2  $V_{IN} - V_o$  (KIA78R06)

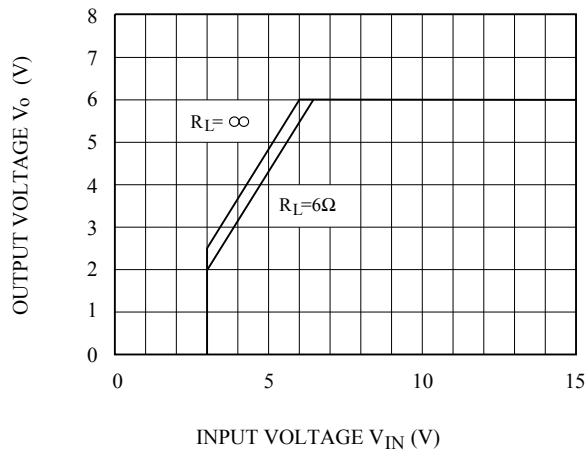
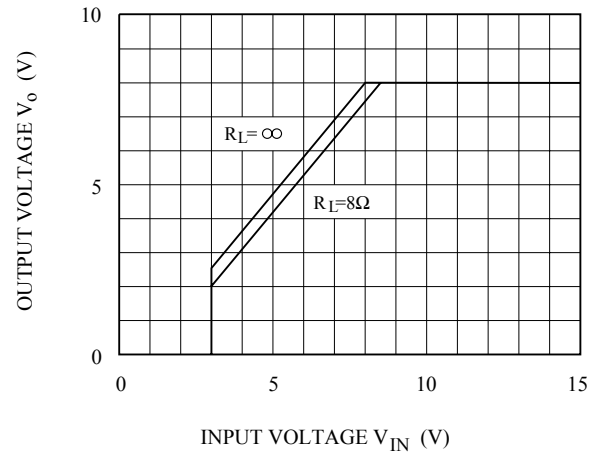

Fig.6-3  $V_{IN} - V_o$  (KIA78R08)



# KIA78R05F~KIA78R15F

Fig.6-4  $V_{IN} - V_o$  (KIA78R09)

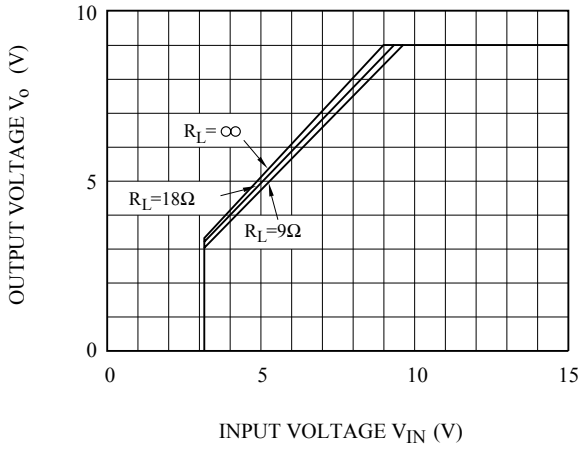

Fig.6-5  $V_{IN} - V_o$  (KIA78R10)

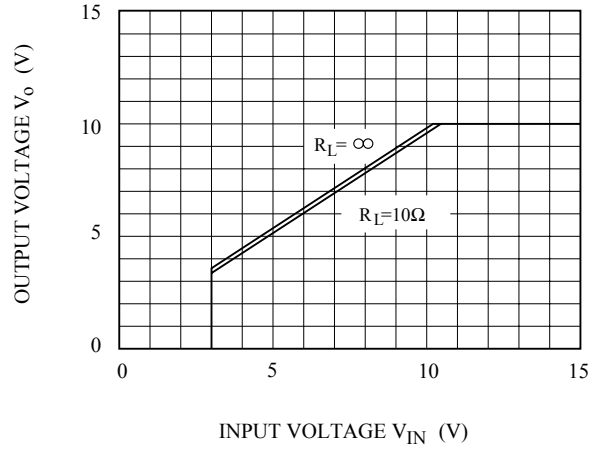

Fig.6-6  $V_{IN} - V_o$  (KIA78R12)

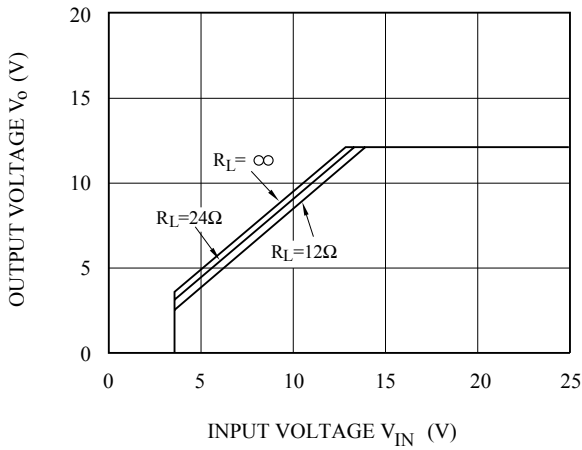

Fig.6-7  $V_{IN} - V_o$  (KIA78R15)

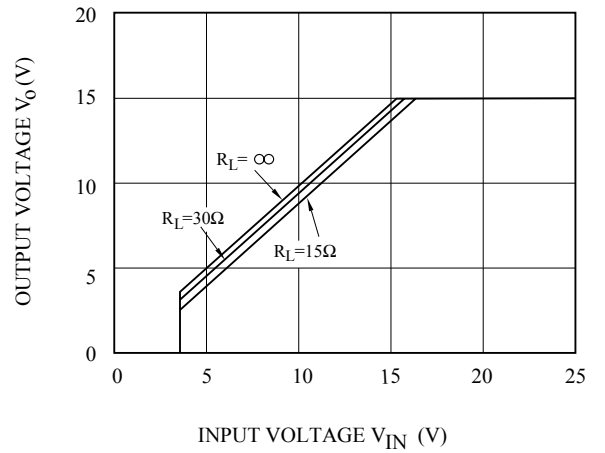

Fig.7-1  $V_{IN} - I_{BIAS}$  (KIA78R05)

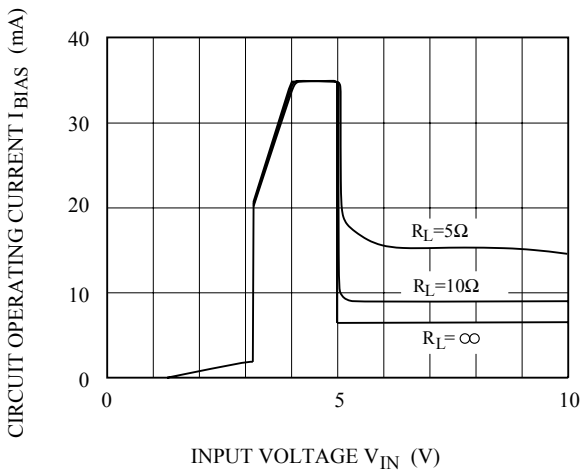
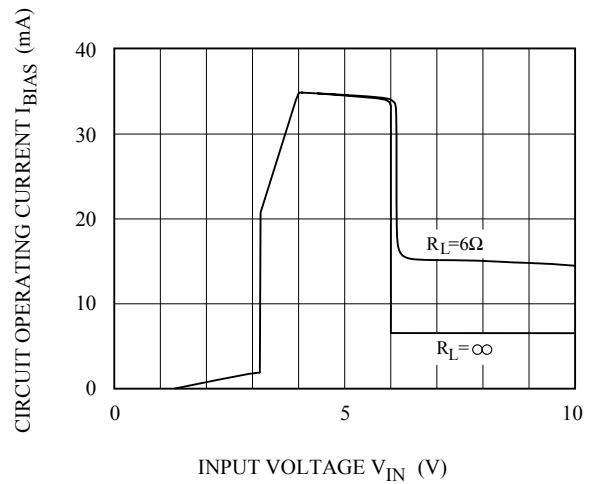

Fig.7-2  $V_{IN} - I_{BIAS}$  (KIA78R06)



# KIA78R05F~KIA78R15F

Fig.7-3  $V_{IN} - I_{BIAS}$  (KIA78R08)

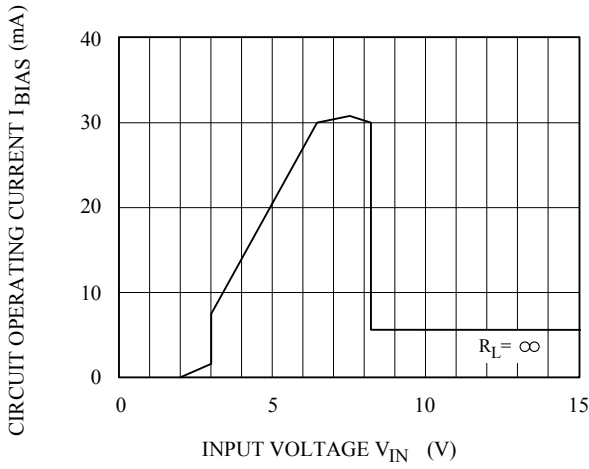

Fig.7-4  $V_{IN} - I_{BIAS}$  (KIA78R09)

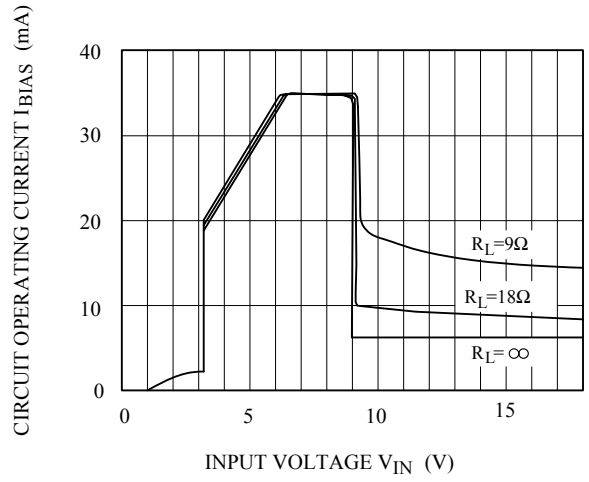

Fig.7-5  $V_{IN} - I_{BIAS}$  (KIA78R10)

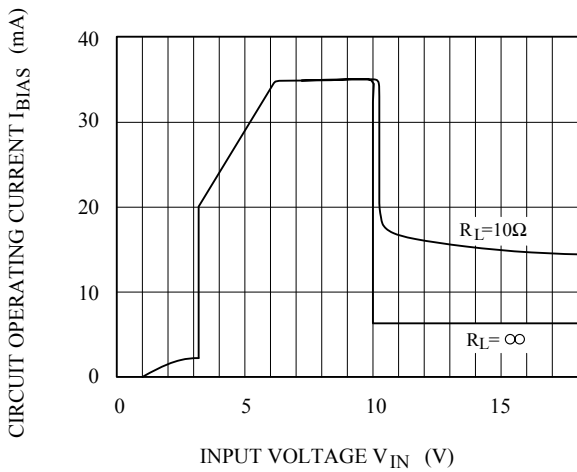

Fig.7-6  $V_{IN} - I_{BIAS}$  (KIA78R12)

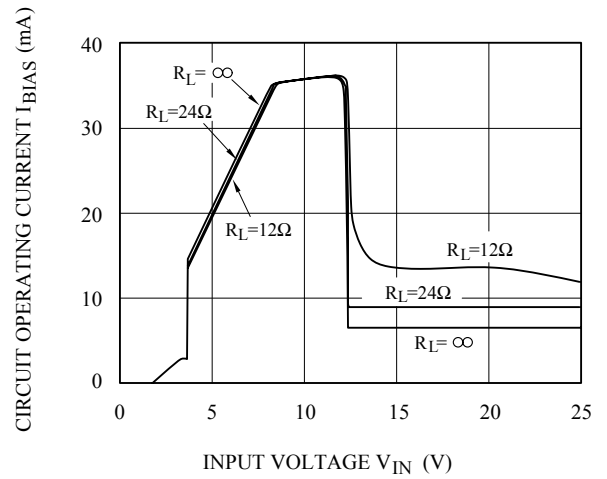

Fig.7-7  $V_{IN} - I_{BIAS}$  (KIA78R15)

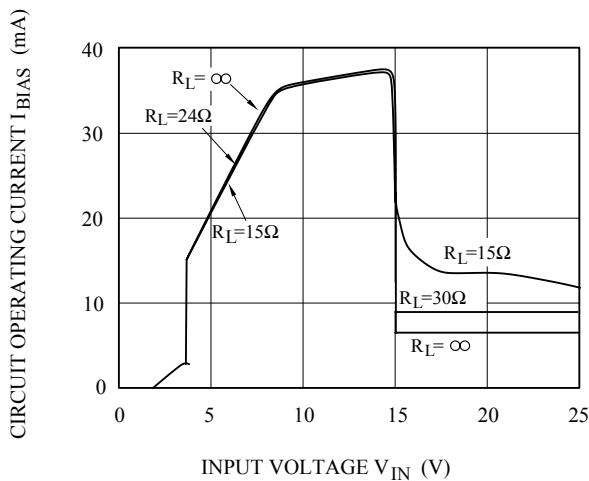
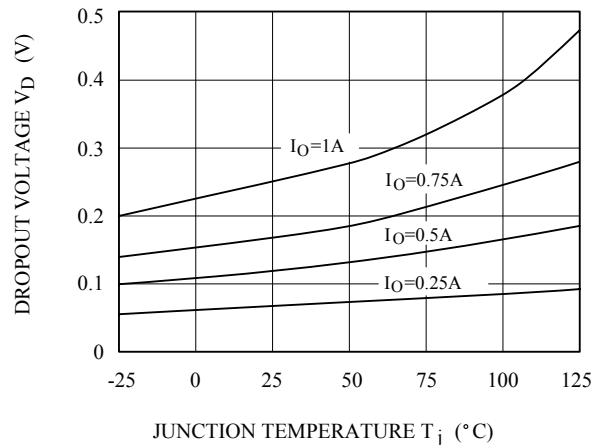

Fig.8  $T_j - V_D$



# KIA78R05F~KIA78R15F

Fig.9  $T_j - I_q$

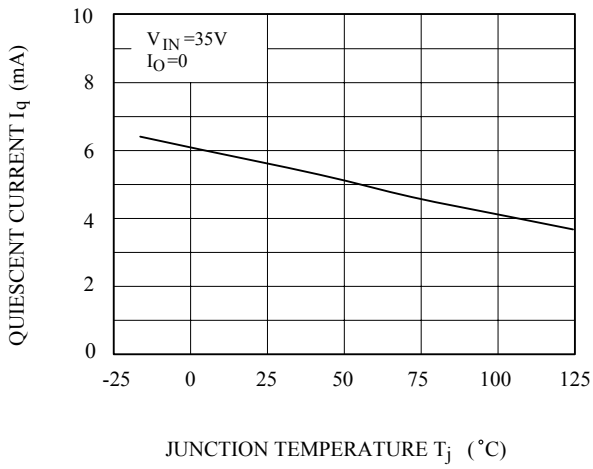

Fig. 10-1  $f - RR$

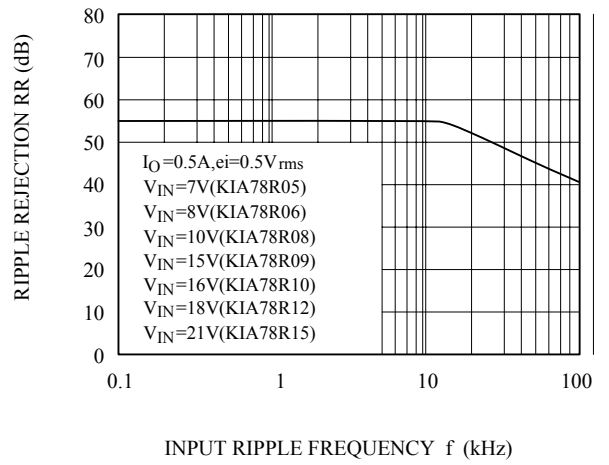

Fig.10-2  $I_O - RR$

