

NPN SILICON EPITAXIAL TRANSISTOR
3 PINS SUPER MINI MOLD

FEATURES

- Excellent Low NF in Low Frequency Band
- Low Voltage Use
- Low C_{ob} : 0.9 pF TYP.
- Low Noise Voltage : 90 mV TYP.
- Super Mini Mold Package. EIAJ : SC-70

ABSOLUTE MAXIMUM RATINGS ($T_a = 25\text{ }^\circ\text{C}$)

Collector to Base Voltage	V_{CBO}	25	V
Collector to Emitter Voltage	V_{CEO}	13	V
Emitter to Base Voltage	V_{EBO}	3.0	V
Collector Current	I_C	50	mA
Total Power Dissipation	P_T	120	mW
Junction Temperature	T_j	125	$^\circ\text{C}$
Storage Temperature	T_{stg}	-55 to +125	$^\circ\text{C}$

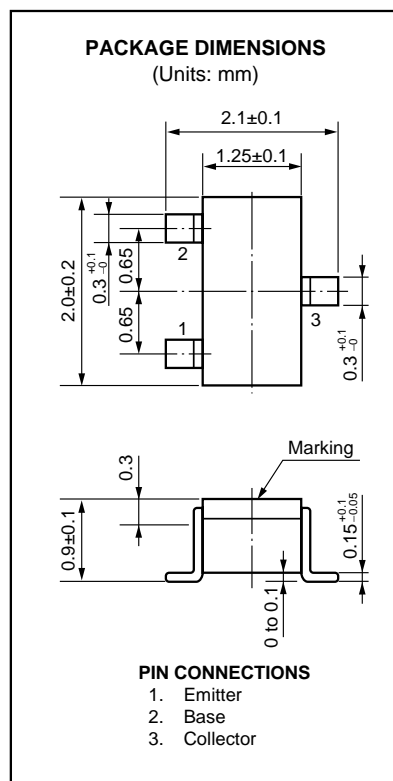

ELECTRICAL CHARACTERISTICS ($T_a = 25\text{ }^\circ\text{C}$)

PARAMETER	SYMBOL	MIN.	TYP.	MAX.	UNIT	TEST CONDITIONS
Collector Cutoff Current	I_{CBO}			0.1	μA	$V_{CB} = 15\text{ V}, I_E = 0$
Emitter Cutoff Current	I_{EBO}			0.1	μA	$V_{EB} = 2\text{ V}, I_C = 0$
Collector to Base Saturation Voltage	$V_{CE(sat)}$			0.3	V	$h_{FE} = 10, I_C = 5\text{ mA}$
DC Current Gain	h_{FE}	60		150		$V_{CE} = 5\text{ V}, I_C = 5\text{ mA}$ *1
Gain Bandwidth Product	f_T	2.5	3.5		GHz	$V_{CE} = 5\text{ V}, I_C = 5\text{ mA}$
Collector Capacitance	C_{ob}		0.8	1.2	pF	$V_{CB} = 5\text{ V}, I_E = 0, f = 1\text{ MHz}$
Insertion Power Gain	$ S_{21e} ^2$	7.0	9.0		dB	$V_{CE} = 5\text{ V}, I_C = 5\text{ mA}, f = 1\text{ GHz}$
Noise Figure	NF		3.0		dB	$V_{CE} = 5\text{ V}, I_C = 5\text{ mA}, f = 1\text{ GHz}$
Noise Voltage	NV		90	200	mV	See Test Circuit

*1 Pulse Measurement $PW \leq 350\text{ }\mu\text{s}$, Duty Cycle $\leq 2\%$

h_{FE} Classification

Rank	R13
Marking	R13
h_{FE}	60 to 150

TYPICAL CHARACTERISTICS (T_A = 25 °C)

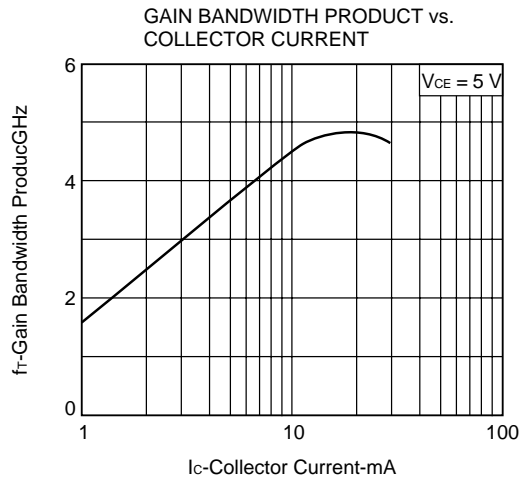
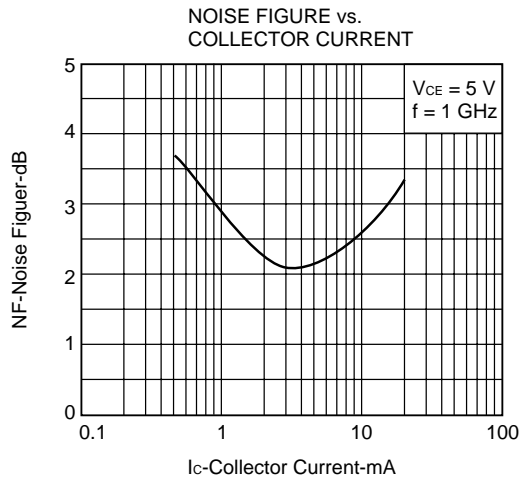
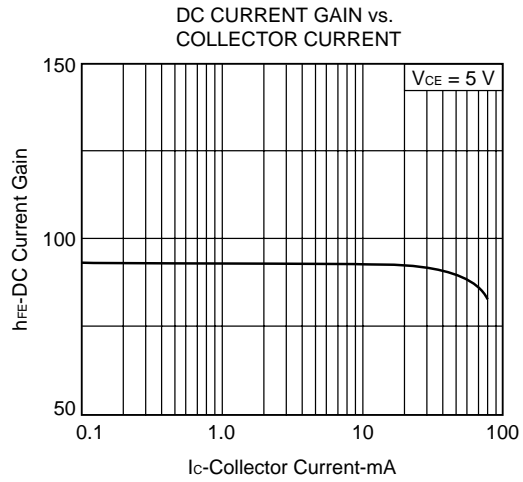
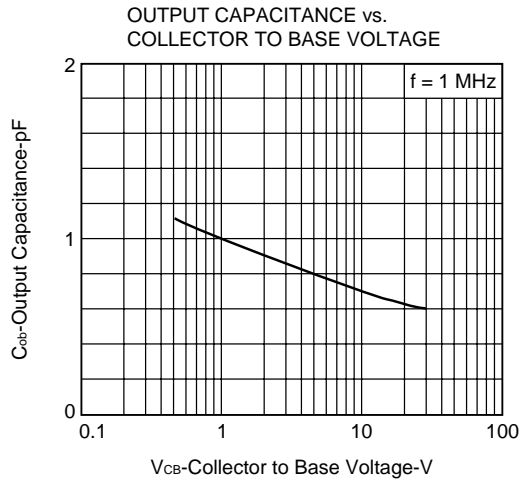
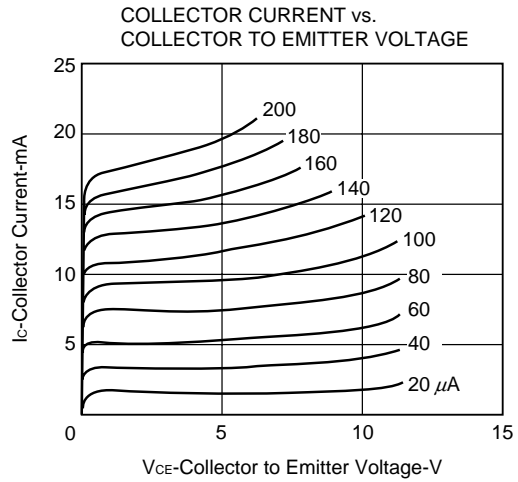
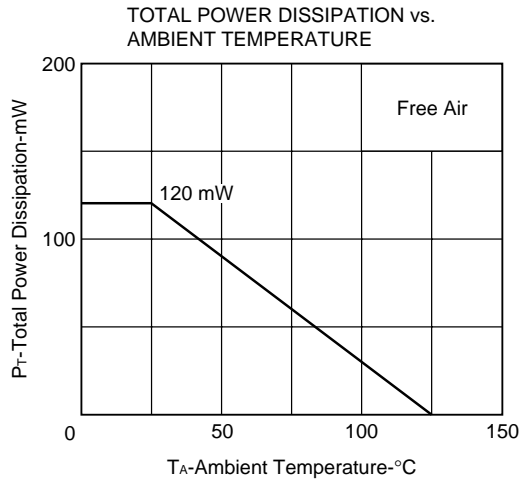

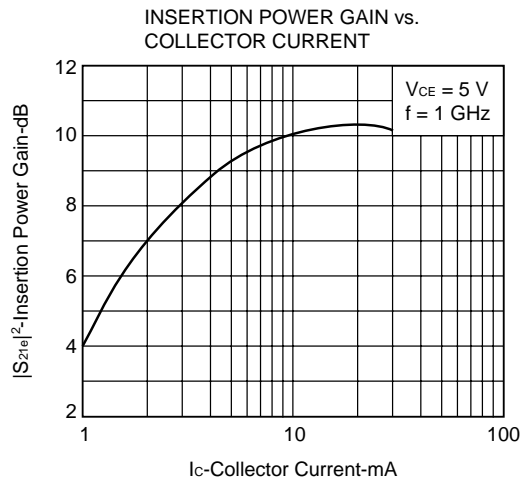

NOISE VOLTAGE TEST CIRCUIT

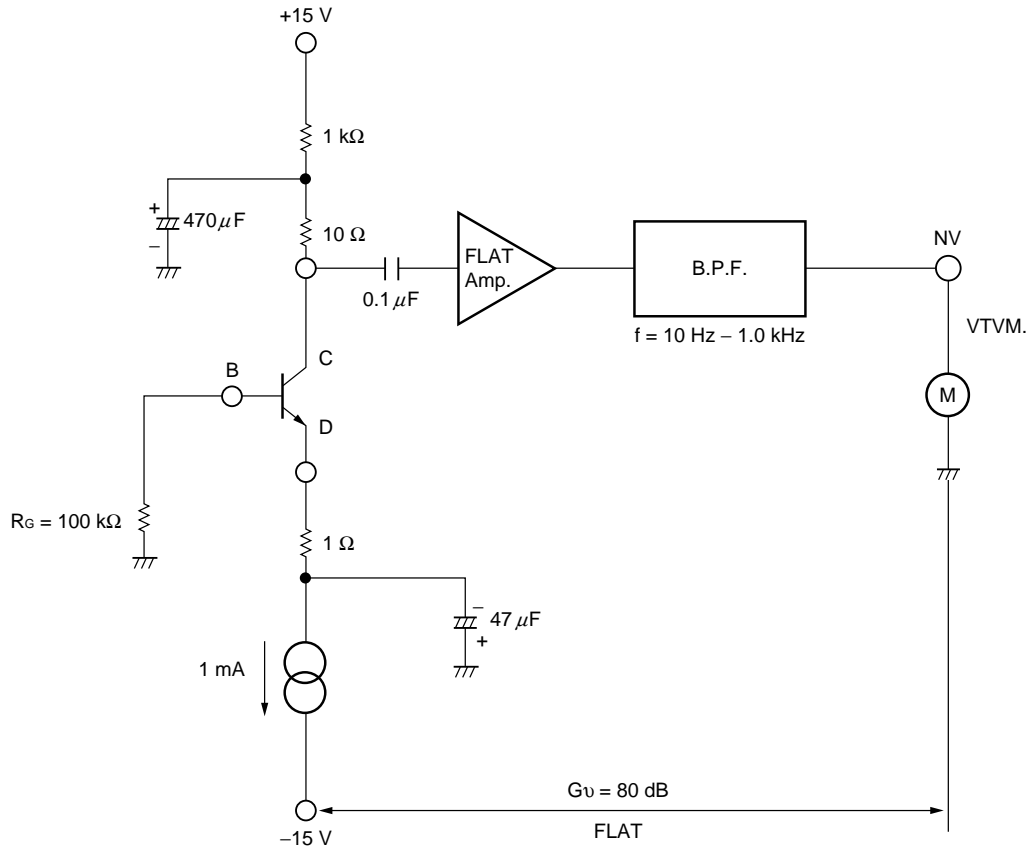

$V_{CE} \approx 5 \text{ V}$, $I_C = 1 \text{ mA}$, $R_G = 100 \text{ k}\Omega$, $G_V = 80 \text{ dB}$, FLAT ($f = 80 \text{ Hz}$ to 1.0 kHz)

S-PARAMETER

(V_{CE} = 5 V, I_c = 5 mA, Z_o = 50 Ω)

FREQUENCY MHz	S ₁₁		S ₂₁		S ₁₂		S ₂₂	
	MAG	ANG	MAG	ANG	MAG	ANG	MAG	ANG
100.00	.825	-29.9	8.599	152.6	.032	69.6	.913	-18.0
200.00	.707	-57.5	7.843	133.7	.052	59.2	.764	-28.7
300.00	.609	-81.0	6.756	119.8	.064	52.2	.653	-34.1
400.00	.515	-103.6	5.998	107.7	.073	50.2	.577	-36.7
500.00	.462	-120.2	5.166	99.0	.080	49.9	.528	-37.8
600.00	.429	-133.1	4.492	92.1	.086	49.9	.493	-39.2
700.00	.408	-144.4	3.971	86.1	.094	50.3	.469	-40.3
800.00	.395	-153.1	3.540	81.0	.100	51.5	.452	-41.6
900.00	.387	-161.0	3.200	76.4	.107	52.3	.440	-43.4
1000.00	.381	-168.0	2.921	72.1	.116	52.9	.430	-44.8
1100.00	.382	-174.0	2.681	68.3	.124	53.3	.424	-46.6
1200.00	.379	-179.6	2.482	64.7	.132	53.6	.417	-48.2
1300.00	.379	175.3	2.319	61.0	.140	53.8	.410	-50.6
1400.00	.380	170.4	2.173	57.6	.148	54.3	.406	-52.7
1500.00	.384	165.9	2.055	54.5	.157	54.3	.402	-55.2
1600.00	.387	161.9	1.942	51.4	.166	54.3	.401	-57.3
1700.00	.392	157.6	1.840	48.2	.175	54.4	.397	-59.9
1800.00	.394	154.1	1.751	45.3	.185	54.2	.397	-62.6
1900.00	.398	150.6	1.686	42.5	.194	53.9	.393	-65.4
2000.00	.403	146.9	1.607	39.7	.203	53.6	.393	-68.0
2100.00	.407	143.8	1.549	37.0	.214	52.9	.391	-71.1
2200.00	.413	140.5	1.488	34.0	.225	52.5	.389	-74.2
2300.00	.419	137.5	1.442	31.6	.235	51.9	.389	-76.9
2400.00	.422	134.6	1.391	29.2	.246	51.3	.389	-80.2
2500.00	.428	131.7	1.349	26.7	.257	50.6	.390	-83.4
2600.00	.431	129.1	1.309	24.4	.268	49.8	.391	-86.2
2700.00	.434	126.2	1.272	22.0	.279	48.9	.388	-89.5
2800.00	.439	123.5	1.238	19.8	.290	48.0	.389	-92.7
2900.00	.446	120.8	1.205	17.7	.302	46.9	.392	-95.7
3000.00	.449	118.1	1.173	15.5	.313	46.1	.391	-99.0

(V_{CE} = 5 V, I_c = 3 mA, Z_o = 50 Ω)

FREQUENCY MHz	S ₁₁		S ₂₁		S ₁₂		S ₂₂	
	MAG	ANG	MAG	ANG	MAG	ANG	MAG	ANG
100.00	.897	-22.4	5.520	157.8	.034	73.0	.951	-13.5
200.00	.812	-44.7	5.218	140.7	.059	60.4	.848	-23.6
300.00	.732	-64.1	4.687	127.6	.075	52.4	.756	-30.2
400.00	.639	-85.1	4.506	115.7	.085	47.9	.678	-33.9
500.00	.575	-101.5	4.069	106.2	.093	45.2	.624	-36.4
600.00	.524	-116.0	3.669	98.0	.100	44.0	.582	-38.4
700.00	.485	-128.8	3.347	90.8	.105	43.0	.554	-40.1
800.00	.462	-138.9	3.016	84.9	.109	43.4	.531	-41.7
900.00	.443	-147.9	2.752	79.5	.114	44.0	.515	-43.6
1000.00	.431	-156.2	2.540	74.8	.119	44.5	.503	-45.4
1100.00	.425	-163.2	2.345	70.4	.125	45.2	.494	-47.4
1200.00	.420	-169.7	2.182	66.4	.130	46.4	.485	-49.0
1300.00	.417	-175.4	2.041	62.2	.136	46.8	.478	-51.4
1400.00	.414	178.9	1.927	58.7	.142	48.2	.472	-53.6
1500.00	.417	173.7	1.815	55.1	.149	48.7	.468	-56.0
1600.00	.418	169.1	1.724	51.8	.156	49.4	.467	-58.4
1700.00	.422	164.3	1.641	48.5	.164	50.0	.461	-61.0
1800.00	.423	160.1	1.563	45.4	.171	50.3	.460	-63.7
1900.00	.426	156.1	1.495	42.5	.180	50.8	.457	-66.5
2000.00	.429	151.9	1.438	39.5	.189	51.2	.454	-69.4
2100.00	.434	148.5	1.384	36.5	.199	51.4	.453	-72.2
2200.00	.439	144.9	1.328	33.8	.210	51.2	.452	-75.4
2300.00	.444	141.4	1.289	31.1	.219	51.2	.451	-78.2
2400.00	.447	138.2	1.244	28.7	.231	51.0	.451	-81.3
2500.00	.453	135.1	1.206	26.2	.241	50.5	.451	-84.5
2600.00	.457	132.2	1.171	23.8	.252	50.1	.453	-87.6
2700.00	.462	129.0	1.138	21.5	.263	49.7	.450	-90.9
2800.00	.465	126.1	1.107	19.3	.274	48.6	.452	-94.0
2900.00	.470	123.1	1.075	17.1	.288	48.1	.454	-97.2
3000.00	.473	120.2	1.048	15.1	.301	47.4	.454	-100.6

S-PARAMETER

(V_{CE} = 5 V, I_C = 1 mA, Z_O = 50 Ω)

FREQUENCY MHz	S ₁₁		S ₂₁		S ₁₂		S ₂₂	
	MAG	ANG	MAG	ANG	MAG	ANG	MAG	ANG
100.00	.959	-15.4	1.976	163.0	.037	78.4	.986	-7.6
200.00	.934	-30.3	1.937	150.1	.069	67.7	.954	-14.3
300.00	.894	-44.3	1.833	138.1	.096	58.6	.912	-20.4
400.00	.837	-59.6	1.886	127.6	.114	51.1	.863	-25.4
500.00	.795	-72.5	1.785	118.4	.128	44.4	.823	-29.2
600.00	.744	-85.9	1.732	109.5	.138	39.7	.785	-32.6
700.00	.696	-98.9	1.706	101.0	.144	35.4	.755	-35.6
800.00	.662	-109.3	1.595	93.5	.147	32.3	.729	-38.4
900.00	.624	-120.3	1.545	86.7	.148	29.4	.708	-41.2
1000.00	.600	-129.5	1.474	80.6	.149	28.2	.693	-43.7
1100.00	.580	-138.2	1.391	75.1	.148	27.2	.681	-46.1
1200.00	.561	-146.6	1.338	69.7	.148	26.7	.668	-48.4
1300.00	.550	-153.6	1.262	64.9	.147	26.7	.658	-51.4
1400.00	.538	-160.9	1.214	60.3	.145	27.4	.650	-53.8
1500.00	.534	-167.6	1.159	56.0	.144	28.5	.645	-56.9
1600.00	.530	-173.5	1.110	52.2	.143	30.4	.641	-59.4
1700.00	.525	-179.6	1.064	48.4	.143	32.5	.635	-62.3
1800.00	.526	175.2	1.018	44.8	.145	34.9	.635	-65.3
1900.00	.526	170.0	.981	41.7	.147	37.5	.632	-68.4
2000.00	.524	165.0	.952	38.3	.152	40.2	.627	-71.5
2100.00	.527	160.4	.914	35.4	.157	42.7	.625	-74.6
2200.00	.529	155.7	.882	32.4	.164	45.1	.621	-78.2
2300.00	.533	151.3	.857	29.9	.172	47.3	.622	-81.1
2400.00	.535	147.3	.827	27.5	.183	48.7	.622	-84.6
2500.00	.539	143.3	.802	25.3	.193	50.0	.621	-88.0
2600.00	.541	139.5	.781	23.0	.205	51.1	.621	-91.3
2700.00	.544	135.5	.759	21.0	.218	51.8	.619	-94.9
2800.00	.546	132.0	.741	19.2	.232	52.1	.619	-98.1
2900.00	.550	128.5	.719	17.5	.248	52.1	.619	-101.7
3000.00	.550	124.9	.702	16.0	.264	52.0	.617	-105.3

(V_{CE} = 3 V, I_C = 5 mA, Z_O = 50 Ω)

FREQUENCY MHz	S ₁₁		S ₂₁		S ₁₂		S ₂₂	
	MAG	ANG	MAG	ANG	MAG	ANG	MAG	ANG
100.00	.821	-31.6	8.542	151.6	.036	68.8	.898	-20.4
200.00	.694	-61.7	7.754	131.9	.058	56.8	.733	-32.5
300.00	.596	-86.5	6.608	117.7	.071	50.5	.613	-38.7
400.00	.511	-109.7	5.804	105.5	.079	48.7	.533	-41.6
500.00	.465	-125.9	4.962	97.0	.087	47.8	.481	-42.9
600.00	.439	-138.8	4.292	90.2	.095	48.1	.444	-44.4
700.00	.420	-149.5	3.782	84.4	.102	48.7	.420	-45.7
800.00	.411	-157.8	3.370	79.4	.110	49.8	.402	-47.1
900.00	.406	-165.4	3.037	74.7	.118	49.5	.388	-48.8
1000.00	.402	-172.0	2.768	70.6	.126	50.8	.379	-50.4
1100.00	.402	-177.8	2.550	66.9	.134	51.5	.371	-52.3
1200.00	.401	176.9	2.358	63.1	.143	51.7	.365	-54.2
1300.00	.403	172.0	2.205	59.4	.151	51.6	.359	-56.8
1400.00	.403	167.4	2.067	56.1	.160	52.3	.355	-58.9
1500.00	.408	163.3	1.953	52.9	.170	52.3	.350	-61.6
1600.00	.410	159.4	1.845	49.6	.179	52.3	.349	-64.1
1700.00	.415	155.3	1.755	46.6	.189	51.9	.345	-67.1
1800.00	.417	151.8	1.673	43.6	.198	51.5	.344	-69.5
1900.00	.422	148.4	1.595	40.8	.208	51.1	.343	-72.8
2000.00	.425	145.0	1.537	38.1	.219	50.8	.341	-75.6
2100.00	.430	141.9	1.481	35.0	.229	50.0	.340	-79.0
2200.00	.435	138.8	1.423	32.5	.241	49.6	.338	-82.4
2300.00	.441	135.7	1.377	30.0	.251	48.9	.338	-85.3
2400.00	.445	132.9	1.329	27.6	.261	48.2	.339	-88.6
2500.00	.449	130.2	1.288	25.2	.273	47.3	.340	-92.0
2600.00	.452	127.5	1.253	22.8	.283	46.6	.343	-95.3
2700.00	.458	124.7	1.218	20.6	.295	45.4	.341	-98.6
2800.00	.461	122.1	1.185	18.4	.306	44.5	.343	-102.0
2900.00	.466	119.6	1.153	16.3	.319	43.5	.346	-105.1
3000.00	.469	116.8	1.124	14.2	.329	42.5	.345	-108.6

S-PARAMETER

(V_{CE} = 3 V, I_c = 3 mA, Z_o = 50 Ω)

FREQUENCY MHz	S ₁₁		S ₂₁		S ₁₂		S ₂₂	
	MAG	ANG	MAG	ANG	MAG	ANG	MAG	ANG
100.00	.880	-24.7	5.495	155.5	.038	71.6	.943	-15.4
200.00	.800	-47.6	5.185	139.2	.067	59.3	.827	-26.6
300.00	.720	-67.8	4.623	125.7	.085	50.5	.724	-33.9
400.00	.628	-89.8	4.411	113.5	.095	46.1	.640	-37.9
500.00	.567	-106.7	3.961	104.0	.103	43.3	.583	-40.7
600.00	.521	-121.1	3.544	95.9	.109	41.9	.539	-42.8
700.00	.488	-133.7	3.211	88.8	.114	41.1	.509	-44.8
800.00	.467	-143.5	2.895	83.0	.119	41.3	.486	-46.5
900.00	.453	-152.5	2.636	77.6	.124	41.6	.468	-48.4
1000.00	.444	-160.4	2.431	72.9	.131	42.4	.456	-50.4
1100.00	.439	-166.9	2.244	68.5	.136	43.2	.447	-52.3
1200.00	.434	-173.2	2.085	64.6	.142	44.1	.437	-54.3
1300.00	.432	-178.8	1.951	60.5	.147	44.5	.429	-56.8
1400.00	.432	176.0	1.836	56.9	.154	45.7	.425	-59.0
1500.00	.434	171.0	1.733	53.3	.161	46.0	.419	-61.8
1600.00	.436	166.4	1.646	49.8	.168	46.7	.418	-64.2
1700.00	.440	161.7	1.568	46.5	.177	47.1	.412	-67.2
1800.00	.442	158.0	1.498	43.5	.185	47.5	.413	-70.0
1900.00	.445	154.0	1.431	40.7	.194	47.8	.410	-73.0
2000.00	.447	150.0	1.381	37.7	.204	48.1	.408	-76.1
2100.00	.453	146.6	1.324	34.8	.213	47.9	.407	-79.1
2200.00	.457	143.3	1.275	32.0	.224	47.7	.404	-82.5
2300.00	.462	139.8	1.236	29.3	.234	47.6	.404	-85.5
2400.00	.466	136.7	1.193	26.9	.244	47.4	.405	-88.8
2500.00	.470	133.5	1.156	24.5	.256	46.8	.406	-92.1
2600.00	.474	130.6	1.123	22.1	.266	46.6	.408	-95.5
2700.00	.479	127.4	1.093	19.9	.278	45.7	.406	-99.0
2800.00	.483	124.7	1.067	17.6	.290	44.8	.409	-102.2
2900.00	.487	121.8	1.036	15.5	.302	44.2	.411	-105.4
3000.00	.489	119.0	1.009	13.5	.316	43.4	.411	-109.0

(V_{CE} = 3 V, I_c = 1 mA, Z_o = 50 Ω)

FREQUENCY MHz	S ₁₁		S ₂₁		S ₁₂		S ₂₂	
	MAG	ANG	MAG	ANG	MAG	ANG	MAG	ANG
100.00	.958	-15.9	1.956	162.3	.041	78.7	.985	-8.5
200.00	.930	-31.7	1.926	148.8	.078	66.6	.945	-16.1
300.00	.885	-46.3	1.817	136.3	.109	56.9	.898	-22.7
400.00	.829	-62.1	1.875	125.5	.129	49.0	.844	-28.0
500.00	.784	-75.4	1.763	116.0	.144	42.6	.800	-32.1
600.00	.734	-89.0	1.710	106.9	.154	37.3	.757	-35.8
700.00	.687	-102.2	1.675	98.3	.160	33.2	.725	-39.0
800.00	.654	-112.7	1.565	90.9	.164	29.8	.698	-41.9
900.00	.619	-123.6	1.509	84.0	.165	27.0	.677	-44.8
1000.00	.595	-132.7	1.435	78.1	.165	25.8	.658	-47.4
1100.00	.579	-141.4	1.356	72.3	.165	24.4	.648	-50.1
1200.00	.561	-149.6	1.300	67.0	.163	24.0	.634	-52.6
1300.00	.552	-156.3	1.225	62.1	.161	23.7	.624	-55.5
1400.00	.541	-163.5	1.178	57.7	.160	24.1	.615	-58.3
1500.00	.540	-169.8	1.124	53.5	.159	25.6	.609	-61.3
1600.00	.535	-175.7	1.076	49.4	.158	27.0	.605	-64.2
1700.00	.532	178.4	1.036	45.7	.157	28.7	.601	-67.2
1800.00	.533	173.2	.988	42.3	.157	30.7	.599	-70.3
1900.00	.535	168.3	.951	39.1	.160	33.0	.596	-73.6
2000.00	.533	163.2	.923	36.0	.164	35.6	.592	-76.9
2100.00	.538	158.8	.887	33.0	.169	38.1	.590	-80.3
2200.00	.539	154.5	.858	30.0	.175	40.2	.585	-83.9
2300.00	.543	150.0	.832	27.5	.184	42.4	.587	-87.1
2400.00	.545	146.1	.803	25.2	.193	43.8	.586	-90.7
2500.00	.548	142.2	.779	23.0	.203	45.4	.587	-94.1
2600.00	.551	138.4	.759	20.8	.215	46.4	.587	-97.8
2700.00	.554	134.7	.738	18.9	.229	47.1	.585	-101.4
2800.00	.556	131.3	.722	17.3	.241	47.5	.584	-105.0
2900.00	.560	127.6	.700	15.6	.257	47.5	.586	-108.6
3000.00	.561	124.1	.682	14.1	.271	47.5	.584	-112.5

S-PARAMETER

(V_{CE} = 1 V, I_c = 3 mA, Z_o = 50 Ω)

FREQUENCY MHz	S ₁₁		S ₂₁		S ₁₂		S ₂₂	
	MAG	ANG	MAG	ANG	MAG	ANG	MAG	ANG
100.00	.875	-28.8	5.383	153.3	.054	68.7	.915	-21.3
200.00	.768	-56.7	5.024	134.1	.089	54.1	.760	-36.1
300.00	.683	-79.9	4.387	119.8	.108	44.9	.633	-45.4
400.00	.603	-103.8	4.057	107.2	.119	40.5	.540	-50.6
500.00	.552	-121.1	3.566	97.8	.128	38.2	.477	-54.2
600.00	.521	-134.7	3.134	89.9	.135	37.0	.431	-57.2
700.00	.501	-146.4	2.803	83.1	.141	36.1	.399	-59.6
800.00	.488	-155.3	2.518	77.4	.146	36.6	.375	-62.0
900.00	.481	-163.2	2.281	72.2	.152	36.7	.358	-64.5
1000.00	.476	-170.1	2.097	67.5	.158	36.9	.345	-67.1
1100.00	.475	-176.0	1.936	63.3	.164	37.6	.336	-69.3
1200.00	.473	178.3	1.807	59.2	.171	38.1	.325	-72.1
1300.00	.473	173.3	1.689	55.2	.178	38.6	.319	-75.1
1400.00	.473	168.7	1.591	51.4	.186	39.3	.313	-77.9
1500.00	.478	164.3	1.509	47.9	.194	39.6	.311	-81.4
1600.00	.480	160.2	1.429	44.6	.201	39.8	.309	-84.2
1700.00	.482	156.1	1.359	41.4	.210	40.1	.306	-87.9
1800.00	.486	152.3	1.305	38.3	.219	40.3	.306	-91.1
1900.00	.489	148.9	1.250	35.5	.228	40.2	.306	-94.6
2000.00	.492	145.2	1.206	32.6	.238	40.1	.306	-98.6
2100.00	.496	142.0	1.158	29.7	.248	39.8	.306	-102.2
2200.00	.501	138.8	1.120	27.0	.259	39.8	.306	-105.8
2300.00	.507	135.7	1.087	24.4	.269	39.4	.309	-109.5
2400.00	.509	132.7	1.051	22.0	.279	38.8	.312	-113.2
2500.00	.514	130.0	1.023	19.7	.291	38.3	.315	-116.9
2600.00	.516	127.0	.994	17.4	.301	37.8	.318	-120.7
2700.00	.521	124.1	.967	15.4	.313	37.0	.321	-124.3
2800.00	.523	121.5	.944	13.3	.324	36.1	.324	-127.8
2900.00	.526	118.7	.920	11.3	.337	35.1	.328	-131.3
3000.00	.529	116.1	.900	9.4	.349	34.4	.332	-135.0

(V_{CE} = 1 V, I_c = 5 mA, Z_o = 50 Ω)

FREQUENCY MHz	S ₁₁		S ₂₁		S ₁₂		S ₂₂	
	MAG	ANG	MAG	ANG	MAG	ANG	MAG	ANG
100.00	.777	-40.1	8.180	146.3	.050	63.4	.849	-28.7
200.00	.656	-76.1	7.303	125.8	.076	50.6	.642	-44.9
300.00	.572	-103.7	6.019	111.1	.089	45.1	.505	-53.4
400.00	.514	-126.3	5.080	99.8	.099	43.2	.421	-57.6
500.00	.486	-141.4	4.275	91.6	.107	43.1	.367	-60.3
600.00	.472	-152.6	3.666	85.1	.116	44.0	.329	-62.9
700.00	.464	-161.6	3.212	79.5	.124	44.4	.303	-65.1
800.00	.459	-169.1	2.847	74.6	.133	45.2	.283	-67.2
900.00	.458	-175.5	2.567	70.0	.142	45.8	.271	-69.6
1000.00	.458	178.8	2.344	65.9	.151	46.3	.260	-72.0
1100.00	.459	173.8	2.156	62.2	.161	46.2	.253	-74.6
1200.00	.460	169.2	1.999	58.3	.170	46.7	.247	-77.2
1300.00	.460	164.9	1.871	54.6	.180	46.6	.241	-80.4
1400.00	.461	160.9	1.755	51.3	.191	46.4	.238	-83.4
1500.00	.467	157.1	1.659	48.1	.201	46.3	.236	-86.8
1600.00	.469	153.5	1.574	44.8	.212	46.0	.236	-89.7
1700.00	.474	149.7	1.501	41.6	.223	45.5	.234	-93.5
1800.00	.476	146.5	1.431	38.8	.233	45.0	.235	-96.7
1900.00	.480	143.4	1.368	36.0	.245	44.4	.234	-100.7
2000.00	.484	140.1	1.323	33.4	.255	43.7	.235	-104.3
2100.00	.487	137.2	1.273	30.5	.267	43.1	.238	-108.3
2200.00	.492	134.5	1.224	27.9	.279	42.3	.240	-112.1
2300.00	.496	131.4	1.190	25.4	.289	41.4	.240	-115.7
2400.00	.499	128.8	1.151	23.1	.300	40.5	.246	-119.3
2500.00	.503	126.2	1.119	20.8	.311	39.4	.248	-122.8
2600.00	.506	123.7	1.088	18.4	.322	38.6	.253	-126.7
2700.00	.509	121.0	1.060	16.4	.334	37.3	.256	-130.1
2800.00	.512	118.4	1.037	14.2	.345	36.2	.259	-133.6
2900.00	.516	116.0	1.009	12.2	.356	35.3	.264	-136.8
3000.00	.519	113.4	.986	10.2	.368	33.9	.267	-140.6

S-PARAMETER

(V_{CE} = 1 V, I_c = 1 mA, Z_o = 50 Ω)

FREQUENCY MHz	S ₁₁		S ₂₁		S ₁₂		S ₂₂	
	MAG	ANG	MAG	ANG	MAG	ANG	MAG	ANG
100.00	.954	-17.7	1.929	160.5	.059	76.3	.976	-11.1
200.00	.914	-35.8	1.909	144.6	.108	63.2	.920	-21.1
300.00	.862	-52.0	1.776	130.9	.146	51.8	.853	-29.4
400.00	.799	-69.5	1.819	119.1	.170	44.0	.783	-35.7
500.00	.749	-84.0	1.707	109.0	.188	36.7	.727	-40.8
600.00	.701	-98.0	1.626	99.3	.198	31.9	.678	-44.9
700.00	.658	-111.6	1.577	90.6	.204	27.2	.642	-48.6
800.00	.628	-122.1	1.464	83.0	.207	23.9	.612	-51.8
900.00	.599	-132.6	1.391	76.2	.207	21.6	.588	-55.2
1000.00	.582	-141.4	1.320	70.2	.207	19.3	.569	-58.3
1100.00	.571	-149.4	1.239	64.5	.206	18.0	.559	-61.3
1200.00	.558	-157.2	1.183	59.4	.203	17.2	.543	-64.2
1300.00	.554	-163.5	1.118	54.4	.201	16.7	.534	-67.6
1400.00	.545	-169.9	1.068	50.0	.198	16.9	.526	-70.7
1500.00	.547	-176.0	1.022	46.0	.196	17.3	.520	-74.4
1600.00	.545	178.6	.979	42.1	.194	18.1	.517	-77.7
1700.00	.546	173.2	.939	38.4	.193	19.7	.512	-81.2
1800.00	.548	168.4	.899	34.9	.192	21.1	.512	-84.8
1900.00	.549	164.0	.865	31.9	.194	23.0	.511	-88.6
2000.00	.550	159.2	.838	29.0	.196	24.9	.507	-92.3
2100.00	.556	155.1	.808	26.1	.200	27.0	.508	-96.0
2200.00	.558	150.9	.782	23.3	.205	29.1	.505	-100.3
2300.00	.563	147.0	.757	20.9	.212	31.0	.507	-103.9
2400.00	.566	143.2	.733	18.8	.219	32.4	.508	-107.8
2500.00	.570	139.5	.713	16.7	.229	33.5	.511	-111.9
2600.00	.573	136.1	.694	14.9	.240	34.8	.511	-115.7
2700.00	.575	132.5	.677	13.2	.252	35.5	.511	-119.7
2800.00	.578	129.1	.661	11.7	.264	36.3	.512	-123.5
2900.00	.583	125.7	.643	10.2	.278	36.5	.515	-127.4
3000.00	.583	122.4	.630	9.0	.293	36.6	.517	-131.5

[MEMO]

[MEMO]

[MEMO]

No part of this document may be copied or reproduced in any form or by any means without the prior written consent of NEC Corporation. NEC Corporation assumes no responsibility for any errors which may appear in this document.

NEC Corporation does not assume any liability for infringement of patents, copyrights or other intellectual property rights of third parties by or arising from use of a device described herein or any other liability arising from use of such device. No license, either express, implied or otherwise, is granted under any patents, copyrights or other intellectual property rights of NEC Corporation or others.

While NEC Corporation has been making continuous effort to enhance the reliability of its semiconductor devices, the possibility of defects cannot be eliminated entirely. To minimize risks of damage or injury to persons or property arising from a defect in an NEC semiconductor device, customers must incorporate sufficient safety measures in its design, such as redundancy, fire-containment, and anti-failure features.

NEC devices are classified into the following three quality grades:

"Standard", "Special", and "Specific". The Specific quality grade applies only to devices developed based on a customer designated "quality assurance program" for a specific application. The recommended applications of a device depend on its quality grade, as indicated below. Customers must check the quality grade of each device before using it in a particular application.

Standard: Computers, office equipment, communications equipment, test and measurement equipment, audio and visual equipment, home electronic appliances, machine tools, personal electronic equipment and industrial robots

Special: Transportation equipment (automobiles, trains, ships, etc.), traffic control systems, anti-disaster systems, anti-crime systems, safety equipment and medical equipment (not specifically designed for life support)

Specific: Aircrafts, aerospace equipment, submersible repeaters, nuclear reactor control systems, life support systems or medical equipment for life support, etc.

The quality grade of NEC devices is "Standard" unless otherwise specified in NEC's Data Sheets or Data Books. If customers intend to use NEC devices for applications other than those specified for Standard quality grade, they should contact an NEC sales representative in advance.

Anti-radioactive design is not implemented in this product.