

Compact Video Driver Series for DSCs and Portable Devices



Compact, Low Current Consumption Single Output Video Drivers

BH76106HFV, BH76109HFV, BH76112HFV, BH76206HFV

No. 09064EAT03

●Description

This video amplifier with built-in LPF uses a full output swing type output stage to make low voltage operation at $V_{CC} = 2.6V$ possible.

In addition to advantages such as a tiny package and low power consumption, bands of the built-in LPF provide for 4.5 MHz products for DSC and other portable equipment and 6 MHz products for equipment such as DVD. Moreover, since it also can be used at $V_{CC} = 5V$, it is suited not only to portable equipment but also to equipment for stationary use.

●Features

- 1) Wide operating voltage range: $V_{CC} = 2.6V \sim 5.5V$
- 2) Built-in 8th order LPF
- 3) Built-in sync-tip clamp circuit
- 4) Compact HVSO6 package (3.0 mm × 1.6 mm × 0.75 mm)
- 5) Built-in standby function Standby current: 0 μA (typ.)
- 6) Selectable gain 6dB (BH76106HFV, BH76206HFV), 9dB (BH76109HFV), 12dB (BH76112HFV)
- 7) Selectable filter characteristics $f = 4.5MHz$ (BH761xxHFV), $f = 6.0MHz$ (BH76206HFV)

●Applications

Mobile phone, DSC, DVC, DVD, and other

●Line up matrix

Product Name	Amplifier Gain (dB)	LPF Frequency (MHz)
BH76106HFV	6	4.5
BH76109HFV	9	4.5
BH76112HFV	12	4.5
BH76206HFV	6	6.0

●Absolute Maximum Ratings

Parameter	Symbol	Rating	Unit
Power Supply Voltage	V_{CC}	7	V
Power Dissipation	P_d	410 *	mW
Operating Temperature Range	T_{opr}	-40~+85	°C
Storage Temperature Range	T_{stg}	-55~+125	°C

* When mounted on a 70 mm × 70 mm × 1.6 mm ROHM standard board, reduce by 4.1mW/°C above $T_a = +25^\circ C$

●Operating Range

Parameter	Symbol	Min.	Typ.	Max.	Unit
Power Supply Voltage	V_{CC}	2.6	3.0	5.5	V

* This product is not designed for protection against radio active rays.

●Electrical Characteristics (Unless otherwise noted, Typ.: Ta = 25 °C, VCC = 3.0 V)

Parameter	Symbol	Typical Values				Unit	Measurement Conditions
		BH76106HFV	BH76109HFV	BH76112HFV	BH76206HFV		
Circuit Current 1	Icc1	7			8	mA	With no signal
Circuit Current 2	Icc2	0.0				μA	In standby
Voltage Gain	Gv	6.0	9.0	12.0	6.0	dB	f=100kHz, Vin =1Vpp
Maximum Output Level	Vomv	2.6				Vpp	f=4.5MHz/100kHz(BH761xxHFV) f=6MHz/100kHz(BH76206HFV)
Frequency Characteristic 1	Gf1	0.1			-0.3	dB	f=4.5MHz/100kHz(BH761xxHFV) f=6MHz/100kHz(BH76206HFV)
Frequency Characteristic 2	Gf2	-4.0				dB	f=8.2MHz/100kHz(BH761xxHFV) f=12MHz/100kHz(BH76206HFV)
Frequency Characteristic 3	Gf3	-45.0			-40.0	dB	f=19MHz/100kHz(BH761xxHFV) f=27MHz/100kHz(BH76206HFV)
Y Channel output S/N	SNY	-67.0				dB	100kHz~500kHz band 75 Ω termination 100% white video signal
C Channel output S/N (AM)	SNCA	-77.0				dB	100kHz~500kHz band 75 Ω termination 100% chroma video signal
C Channel output S/N (PM)	SNCP	-65.0				dB	100kHz~500kHz band 75 Ω termination 100% chroma video signal
Differential Gain	DG	0.7			0.8	%	VIN = 1.0 Vp-p Standard stair-step signal
Differential Phase	DP	0.7			0.8	deg	VIN = 1.0 Vp-p Standard stair-step signal
Standby Switching Voltage High Level	VthH	1.2~Vcc				V	Standby OFF
Standby Switching Voltage Low Level	VthL	0~0.45				V	Standby ON
Standby Switch Input Current High Level	IthH	45			66	μA	Applying 3.0 V to Pin 6

●Control pin settings

Parameter	State	Function
Standby (Pin 6)	H	Active
	L	Standby
	OPEN	Standby

●Block Diagram

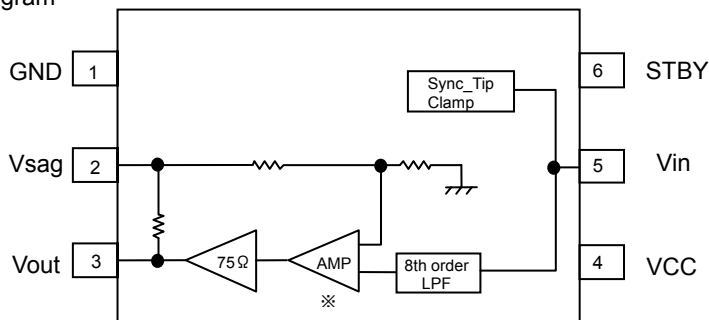

Fig.1

※ BH76106HFV :6dB
BH76109HFV :9dB
BH76112HFV :12dB
BH76206HFV :6dB

●Pin Descriptions

(Typical voltage is that when Vcc = 3.0 V, Ta = 25 °C)

Pin No.	Pin Name	IN	OUT	Typical voltage	Equivalent Circuit	Function
4	Vcc	-	-	3.0V		Power supply pin

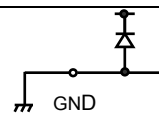
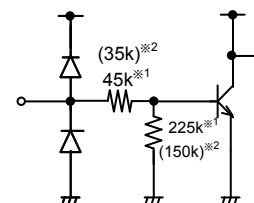
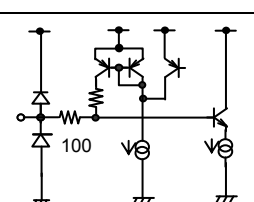
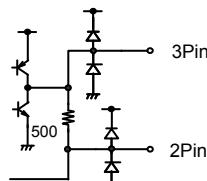
Pin No.	Pin Name	IN	OUT	Typical voltage	Equivalent Circuit	Function
1	GND	-	-	0V		GND pin
6	Stnby	○	-	-		Standby pin HIGH: Active LOW: Standby ※1 BH76106HFV BH76109HFV BH76112HFV ※2 BH76206HFV
5	Vin	○	-	1.4V		Video signal input pin This is a sync-tip clamp format video signal input pin. For the coupling capacitor, 0.1 μF is recommended.
2 3	Vsag Vout	-	○	0.2V		Video signal output pin Video signal SAG correction pin

※The values show above (Voltage and resistance values) are reference values used for description, and are not guaranteed.

●Cautions on Use

- (1) Numeric values and data that are cited are representative design values and their values are not guaranteed.
- (2) Although we are confident recommending the application circuit example, carefully check the characteristics further in conjunction with its use. If using it after modifying externally attached component constants, try to determine adequate margins by including not just static characteristics but also transient characteristics to take into account variations in externally attached components and the ROHM LSI.
- (3) Absolute maximum ratings
If absolute maximum ratings such as applied voltage and operating temperature range are exceeded, the IC may be damaged. Do not apply voltages or temperatures that exceed the absolute maximum ratings. If you are considering circumstances in which an absolute maximum rating would be exceeded, implement physical safety measures such as fuses and investigate ways of not applying conditions exceeding absolute maximum ratings to the LSI.
- (4) GND potential
Even if the voltage of the GND pin is left in an operating state, make it the minimum voltage. Actually confirm that the voltage of each pin does not become a lower voltage than the GND pin, including for transient phenomena.
- (5) Thermal design
Perform thermal design in which there are adequate margins by taking into account the allowable dissipation under conditions of actual use.
- (6) Shorts between pins and mounting errors
When mounting the LSI on a board, be careful of the direction of the LSI and of misalignment. If mounted badly and current is passed through it, the LSI may be damaged. The LSI also may be damaged if shorted by a foreign substance getting in between LSI pins, between a pin and the power supply, or between a pin and GND.
- (7) Operation in a strong electromagnetic field
Since the LSI could malfunction if used in a strong electromagnetic field, evaluate this carefully.
- (8) Input termination resistor
Since there is a risk of oscillation at low temperatures (approximately -60 °C) if the termination resistor of the input pin is made high impedance, set it to no more than 700 Ω.

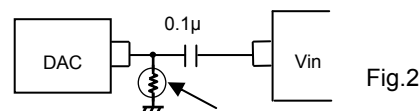

If the termination resistor of the input pin is greater than 700 Ω, connect it as shown in the figure below.

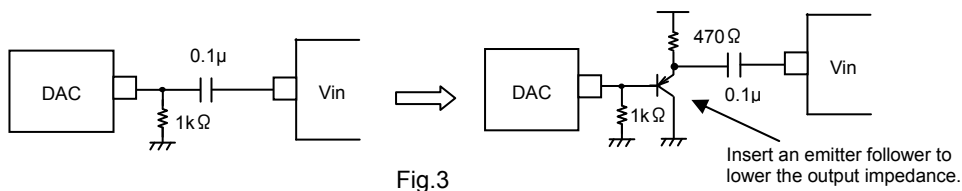

(9) Standby pin

When the standby pin is open, the LSI is in a standby state.

Since adding a voltage greater than V_{CC} at the standby pin turns a protective diode ON, make this at most $V_{CC}+0.2V$ (no greater than $V_{CC}+V_F$). (See Fig. 4) Applying a voltage to the standby pin when the voltage V_{CC} is not being applied also turns the protective diode ON, so do not apply a voltage.

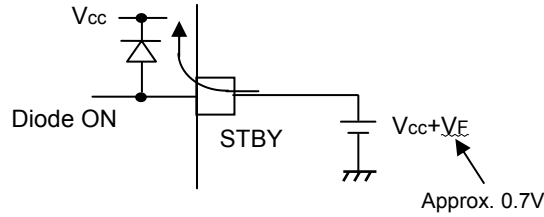

Fig.4

Responsiveness of Standby Control

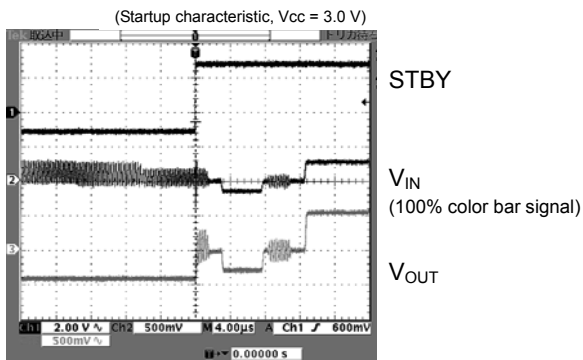

Fig.5 Standby Response Characteristic

※In relation to IC startup, this is practically 0 μ s.
Noise also does not occur when toggling the switch.

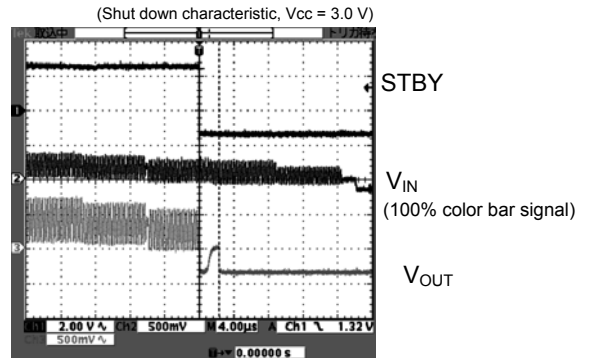

Fig.6 Standby Response Characteristic

※In relation to IC shutdown, this is after approximately 2 μ s.

(10) Input coupling capacitor

Making the input coupling capacitor a value less than 0.1 μ F (the recommended value) increases SAG. Determine the capacitance of the input capacitor used after taking into consideration the relationship of SAG to input coupling capacitor.

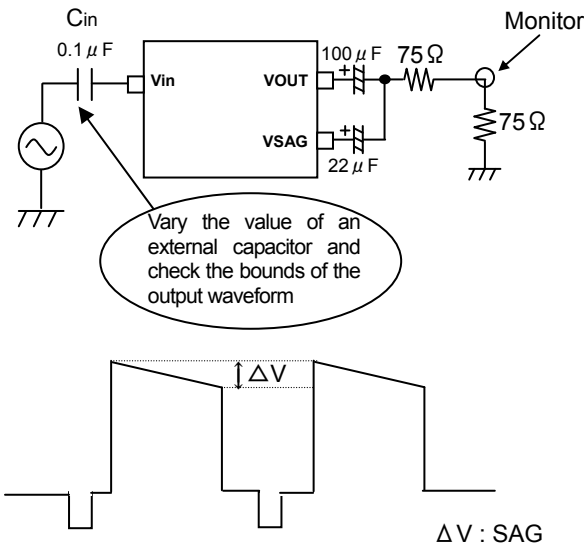
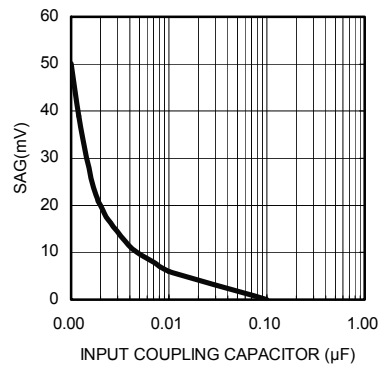

Fig.7



Relationship of SAG to Input Coupling Capacitor

Fig.8

Moreover, if you make the input coupling capacitor a value greater than 0.1 μ F (the recommended value), it may take time for the output waveform to stabilize. Decide the value of the coupling capacitor used by referring to the results shown in Fig. 10.

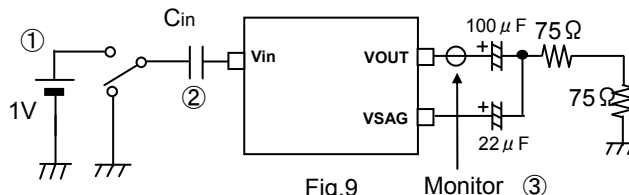
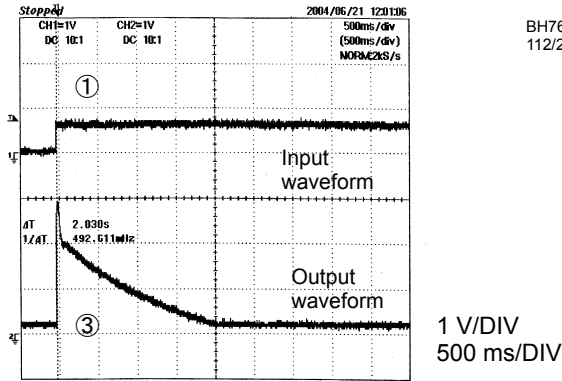

Fig.9



BH76106/109/
112/206HFV

1. When input coupling capacitor (②) is 0.1 μF
Time until output voltage stabilizes (③): 214 ms
2. When input coupling capacitor (②) is 0.56 μF
Time until output voltage stabilizes (③): 1.11 s
3. When input coupling capacitor (②) is 1 μF
Time until output voltage stabilizes (③): 2.03 s

Fig10 Relationship of Output Voltage to Input Voltage
(For BH76106HFV $C_{in}=1\mu\text{F}$)

(11) SAG correction

In order to make the SAG of the video signal as small as possible, we recommend the values of the application circuit diagram for output coupling capacitor capacitance.

If reducing capacitance due to the demands of miniaturization or the like, check the SAG characteristic for an alternating black and white bounce signal *1, Hbar signal *2, or other signal for which a SAG effect readily occurs and use a capacitance that satisfies the demands of the set being used.

As a reference, try the combinations shown below when reducing capacitance. As the capacitance of the V_{out} capacitor is made smaller, SAG becomes greater.

*1,*2: TG-7 U705 unit or other

V_{sag} Capacitor (C1)	33 μF	33 μF	33 μF
V_{out} Capacitor (C2)	68 μF	47 μF	33 μF

(12) Using after removing output coupling capacitor

An application circuit that is an example of use after removing the output coupling capacitor is shown in the figure below.

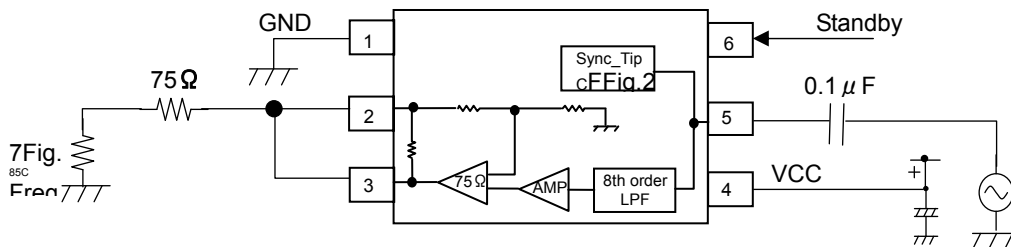

Fig.11

By eliminating the output coupling capacitor, not only can you reduce board space and product cost, but improvement of the SAG characteristic also can be realized due to the fact that the low-band frequency characteristic is improved. However, since direct current will flow in a set connected on the opposite side due to eliminating the output coupling capacitor, pay close attention to the specifications of what is connected in conjunction with using it.

Moreover, characteristics such as circuit current, differential gain, and differential phase differ as shown below.

Parameter	With Output Coupling Capacitor	Without Output Coupling Capacitor
Circuit Current (If no signal)	7.1 mA	7.8 mA
Circuit Current (If color bar signal output)	8.3 mA	14.3 mA
Differential Gain (DG)	0.7%	1.0%
Differential Phase (DP)	0.7°	0.3°

The values shown above are reference values. They are not guaranteed values.

(13) Output dynamic range

The output dynamic range depends on the power supply voltage.

Be careful when using the LSI at low voltage.

The relationship of dynamic range to V_{cc} is shown in Fig. 19.

(14) Bypass capacitor

Since there is a risk of high frequency oscillation, position the power supply bypass capacitor as close as possible to the Vcc pin.

(15) Metal part of back of package

The metal part of the back of the package of this IC also serves as a heat sink. Since it is connected to the GND of the IC, when mounting the IC, connect it to GND or make it NC. Moreover, since there is a risk of shorting, avoid passing a wire other than a GND under the IC.

(16) HVSO6 Reference mounting pattern

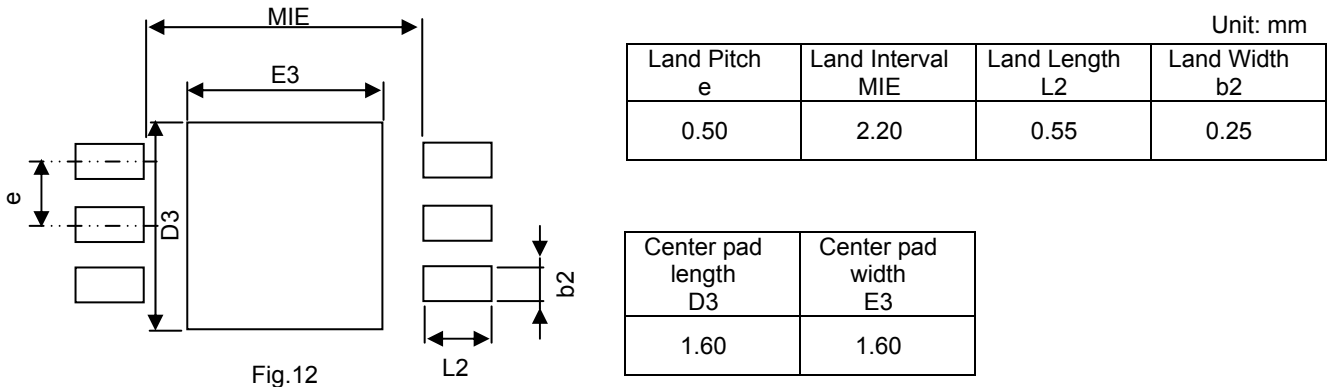

Fig.12

●Application Circuit Example

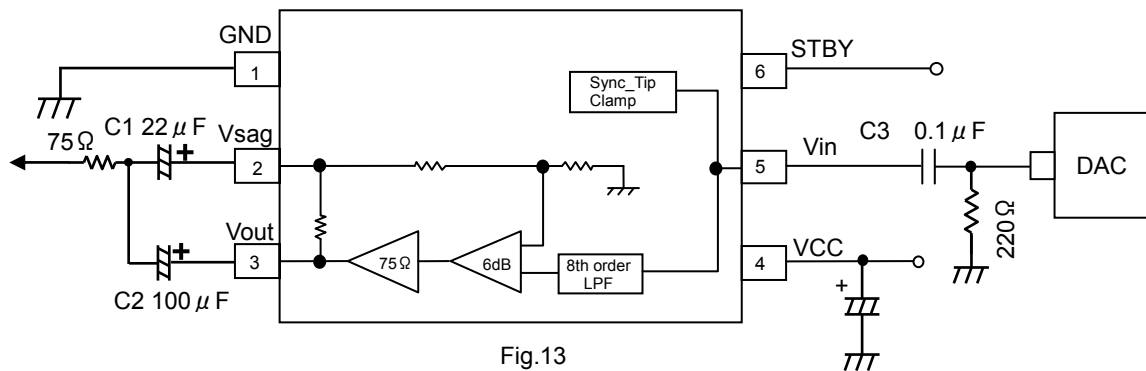

Fig.13

●Reference Data

※Values shown below are reference values. They are not guaranteed values.

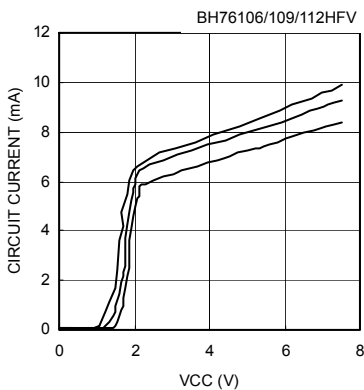

Fig.14 Supply Voltage-Circuit Current

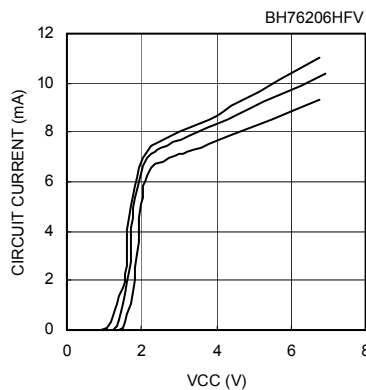

Fig.15 Supply Voltage-Circuit Current

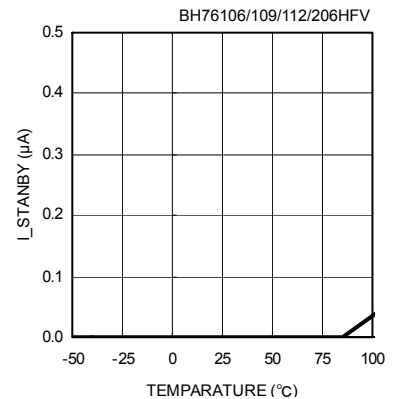

Fig.16 Temperature-Standby Circuit Current

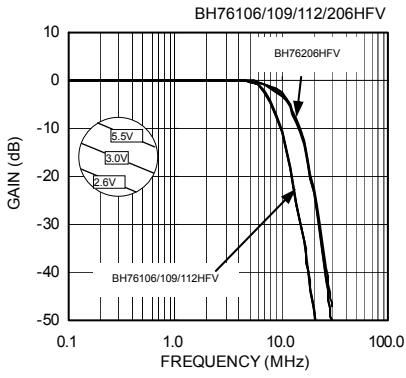

Fig.17 Frequency Characteristic (VCC Characteristic)

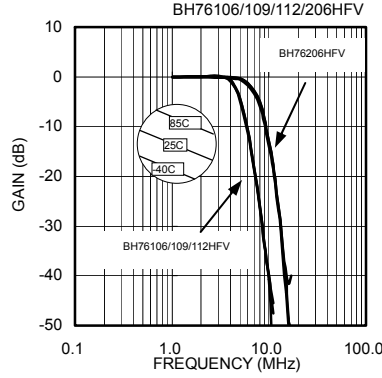

Fig.18 Frequency Characteristic (Temperature Characteristic)

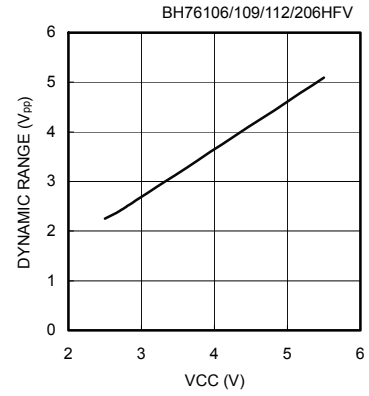

Fig.19 Dynamic Range Characteristic (VCC Characteristic)

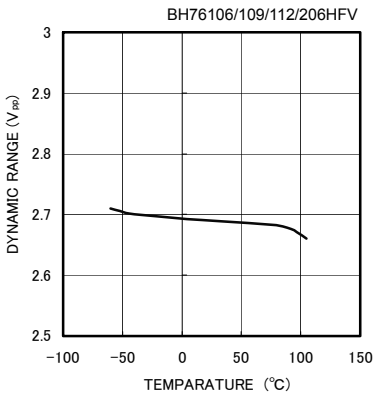

Fig.20 Dynamic Range Characteristic (Temperature Characteristic)

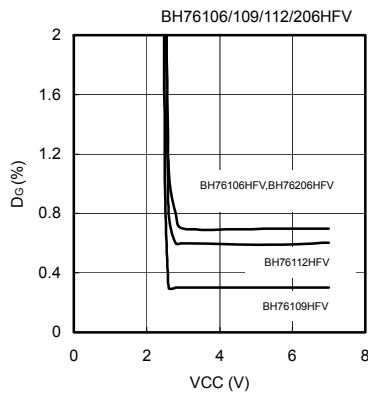

Fig.21 Supply Voltage-D_G

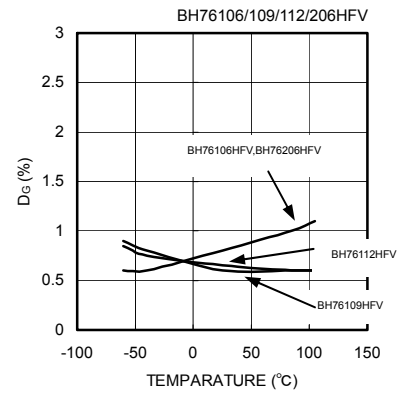

Fig.22 Temperature-D_G

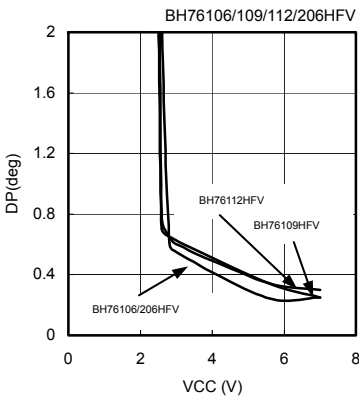

Fig.23 Supply Voltage-D_P

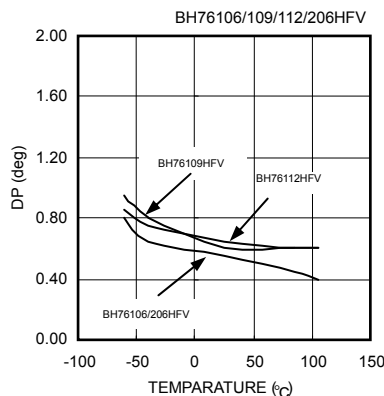

Fig.24 Temperature-D_P

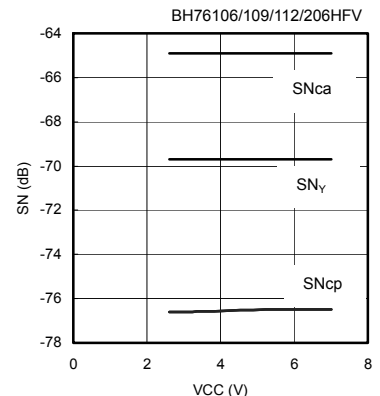

Fig.25 Supply Voltage-S/N

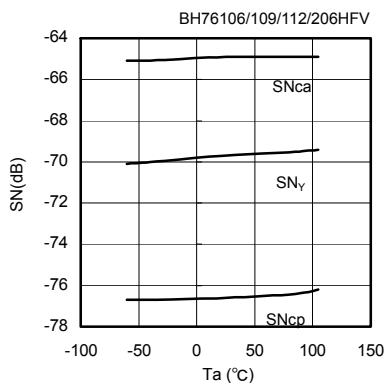

Fig.26 Temperature-S/N

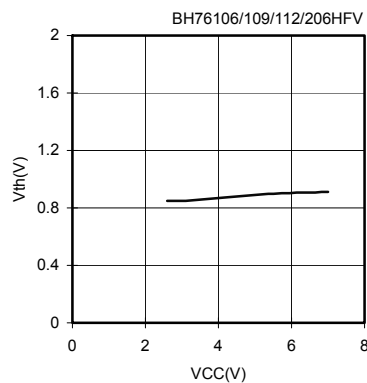

Fig.27 Supply Voltage-V_{th}

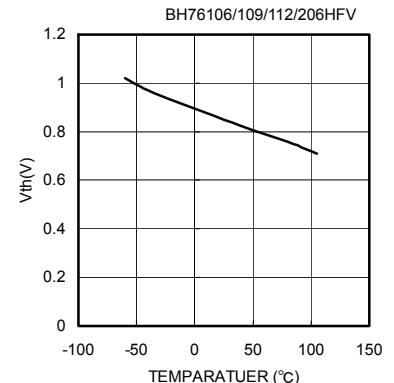
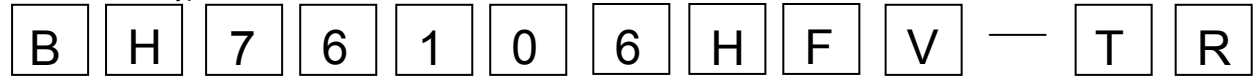

Fig.28 Temperature-V_{th}

● Selection of order type



Part No.

Tape and Reel information

- BH76106HFV
- BH76109HFV
- BH76112HFV
- BH76206HFV

HVSOF6

<Dimension>

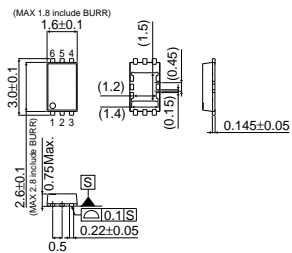

(Unit:mm)

<Tape and Reel information>

Tape	Embossed carrier tape
Quantity	3000pcs
Direction of feed	TR (The direction is the 1pin of product is at the upper light when you hold reel on the left hand and you pull out the tape on the right hand)

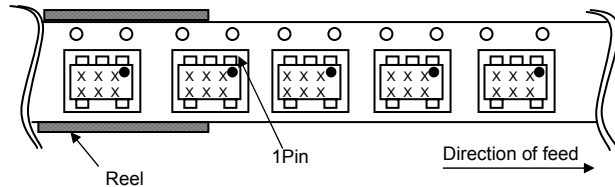

※When you order , please order in times the amount of package quantity.

Notes

No copying or reproduction of this document, in part or in whole, is permitted without the consent of ROHM Co.,Ltd.

The content specified herein is subject to change for improvement without notice.

The content specified herein is for the purpose of introducing ROHM's products (hereinafter "Products"). If you wish to use any such Product, please be sure to refer to the specifications, which can be obtained from ROHM upon request.

Examples of application circuits, circuit constants and any other information contained herein illustrate the standard usage and operations of the Products. The peripheral conditions must be taken into account when designing circuits for mass production.

Great care was taken in ensuring the accuracy of the information specified in this document. However, should you incur any damage arising from any inaccuracy or misprint of such information, ROHM shall bear no responsibility for such damage.

The technical information specified herein is intended only to show the typical functions of and examples of application circuits for the Products. ROHM does not grant you, explicitly or implicitly, any license to use or exercise intellectual property or other rights held by ROHM and other parties. ROHM shall bear no responsibility whatsoever for any dispute arising from the use of such technical information.

The Products specified in this document are intended to be used with general-use electronic equipment or devices (such as audio visual equipment, office-automation equipment, communication devices, electronic appliances and amusement devices).

The Products specified in this document are not designed to be radiation tolerant.

While ROHM always makes efforts to enhance the quality and reliability of its Products, a Product may fail or malfunction for a variety of reasons.

Please be sure to implement in your equipment using the Products safety measures to guard against the possibility of physical injury, fire or any other damage caused in the event of the failure of any Product, such as derating, redundancy, fire control and fail-safe designs. ROHM shall bear no responsibility whatsoever for your use of any Product outside of the prescribed scope or not in accordance with the instruction manual.

The Products are not designed or manufactured to be used with any equipment, device or system which requires an extremely high level of reliability the failure or malfunction of which may result in a direct threat to human life or create a risk of human injury (such as a medical instrument, transportation equipment, aerospace machinery, nuclear-reactor controller, fuel-controller or other safety device). ROHM shall bear no responsibility in any way for use of any of the Products for the above special purposes. If a Product is intended to be used for any such special purpose, please contact a ROHM sales representative before purchasing.

If you intend to export or ship overseas any Product or technology specified herein that may be controlled under the Foreign Exchange and the Foreign Trade Law, you will be required to obtain a license or permit under the Law.



Thank you for your accessing to ROHM product informations.
More detail product informations and catalogs are available, please contact us.

ROHM Customer Support System

<http://www.rohm.com/contact/>