



1.25-W MONO FULLY DIFFERENTIAL AUDIO POWER AMPLIFIER

FEATURES

- 1.25 W Into 8 Ω From a 5-V Supply at THD = 1% (Typ)
- Low Supply Current: 1.7 mA typ
- Shutdown Control <1 μ A
- Only Five External Components
 - Improved PSRR (90 dB) and Wide Supply Voltage (2.5 V to 5.5 V) for Direct Battery Operation
 - Fully Differential Design Reduces RF Rectification
 - Improved CMRR Eliminates Two Input Coupling Capacitors
 - $C_{(BYPASS)}$ Is Optional Due to Fully Differential Design and High PSRR
 - ZQV (Pb - free) and GQV Options
- Available in a 2 mm x 2 mm MicroStar Junior™ BGA Package
 - ZQV (Pb - free) and GQV Options

APPLICATIONS

- Designed for Wireless or Cellular Handsets and PDAs

DESCRIPTION

The TPA6203A1 is a 1.25-W mono fully differential amplifier designed to drive a speaker with at least 8- Ω impedance while consuming less than 37 mm² total printed-circuit board (PCB) area in most applications. This device operates from 2.5 V to 5.5 V, drawing only 1.7 mA of quiescent supply current. The TPA6203A1 is available in the space-saving 2 mm x 2 mm MicroStar Junior™ BGA package.

Features like 85-dB PSRR from 90 Hz to 5 kHz, improved RF-rectification immunity, and small PCB area makes the TPA6203A1 ideal for wireless handsets. A fast start-up time of 4 μ s with minimal pop makes the TPA6203A1 ideal for PDA applications.

APPLICATION CIRCUIT

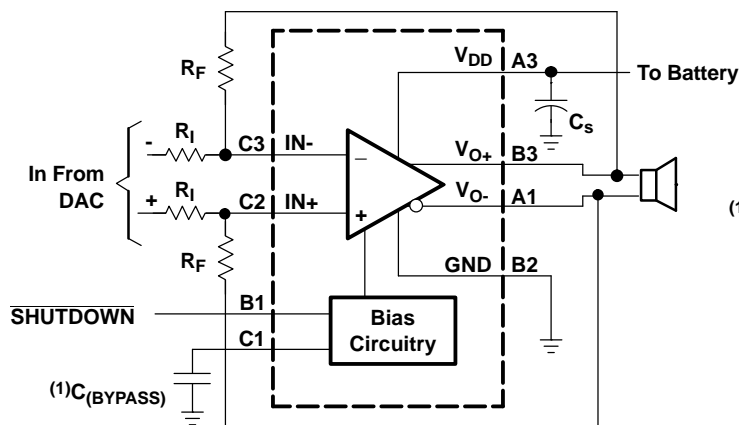

(1) $C_{(BYPASS)}$ is optional

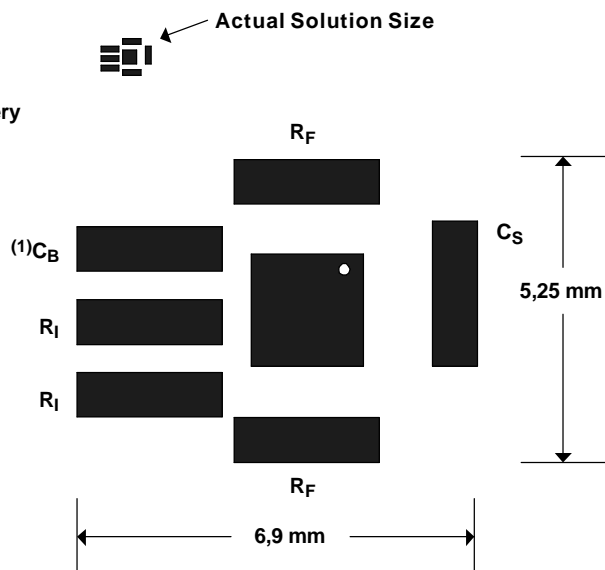

MicroStar Junior is a trademark of Texas Instruments.



Please be aware that an important notice concerning availability, standard warranty, and use in critical applications of Texas Instruments semiconductor products and disclaimers thereto appears at the end of this data sheet.



These devices have limited built-in ESD protection. The leads should be shorted together or the device placed in conductive foam during storage or handling to prevent electrostatic damage to the MOS gates.

ABSOLUTE MAXIMUM RATINGS

over operating free-air temperature range unless otherwise noted (1)

		UNIT
Supply voltage, V_{DD}		-0.3 V to 6.0 V
Input voltage, V_I		-0.3 V to $V_{DD} + 0.3V$
Continuous total power dissipation		See Dissipation Rating Table
Operating free-air temperature, T_A		-40°C to 85°C
Junction temperature, T_J		-40°C to 125°C
Storage temperature, T_{stg}		-65°C to 150°C
Lead temperature 1,6 mm (1/16 Inch) from case for 10 seconds	ZQV	260°C
	GQV	235°C

- (1) Stresses beyond those listed under "absolute maximum ratings" may cause permanent damage to the device. These are stress ratings only, and functional operation of the device at these or any other conditions beyond those indicated under "recommended operating conditions" is not implied. Exposure to absolute-maximum-rated conditions for extended periods may affect device reliability.

RECOMMENDED OPERATING CONDITIONS

		MIN	TYP	MAX	UNIT
Supply voltage, V_{DD}		2.5		5.5	V
High-level input voltage, V_{IH}	SHUTDOWN	2			V
Low-level input voltage, V_{IL}	SHUTDOWN			0.8	V
Common-mode input voltage, V_{IC}	$V_{DD} = 2.5 V, 5.5 V, CMRR \leq -60 dB$	0.5		$V_{DD}-0.8$	V
Operating free-air temperature, T_A		-40		85	°C

DISSIPATION RATINGS

PACKAGE	$T_A \leq 25^\circ C$ POWER RATING	DERATING FACTOR	$T_A = 70^\circ C$ POWER RATING	$T_A = 85^\circ C$ POWER RATING
GQV, ZQV	885 mW	8.8 mW/°C	486 mW	354 mW

ORDERING INFORMATION

	PACKAGED DEVICES (1) (2)	
	MICROSTAR JUNIOR™ (GQV)	MICROSTAR JUNIOR™ (ZQV)
Device	TPA6203A1GQVR	TPA6203A1ZQVR
Symbolization	AADI	AAEI

- (1) The GQV is the standard MicroStar Junior package. The ZQV is a lead-free option and is qualified for 260° lead-free assembly.
 (2) The GQV and ZQV packages are only available taped and reeled. The suffix R designates taped and reeled parts.

ELECTRICAL CHARACTERISTICS
 $T_A = 25^\circ\text{C}$, Gain = 1 V/V

PARAMETER		TEST CONDITIONS	MIN	TYP	MAX	UNIT	
$ V_{ool} $	Output offset voltage (measured differentially)	$V_I = 0\text{ V}$, $V_{DD} = 2.5\text{ V to }5.5\text{ V}$			9	mV	
PSRR	Power supply rejection ratio	$V_{DD} = 2.5\text{ V to }5.5\text{ V}$		-90	-70	dB	
CMRR	Common-mode rejection ratio	$V_{DD} = 3.6\text{ V to }5.5\text{ V}$, $V_{IC} = 0.5\text{ V to }V_{DD}-0.8$		-70	-65	dB	
		$V_{DD} = 2.5\text{ V}$, $V_{IC} = 0.5\text{ V to }1.7\text{ V}$		-62	-55		
V_{OL}	Low-level output voltage	$R_L = 8\ \Omega$, $V_{IN+} = V_{DD}$, $V_{IN-} = 0\text{ V}$ or $V_{IN+} = 0\text{ V}$, $V_{IN-} = V_{DD}$	$V_{DD} = 5.5\text{ V}$		0.30	0.46	V
			$V_{DD} = 3.6\text{ V}$		0.22		
			$V_{DD} = 2.5\text{ V}$		0.19	0.26	
V_{OH}	High-level output voltage	$R_L = 8\ \Omega$, $V_{IN+} = V_{DD}$, $V_{IN-} = 0\text{ V}$ or $V_{IN+} = 0\text{ V}$, $V_{IN-} = V_{DD}$	$V_{DD} = 5.5\text{ V}$	4.8	5.12		V
			$V_{DD} = 3.6\text{ V}$		3.28		
			$V_{DD} = 2.5\text{ V}$	2.1	2.24		
$ I_{IH} $	High-level input current	$V_{DD} = 5.5\text{ V}$, $V_I = 5.8\text{ V}$			1.2	μA	
$ I_{IL} $	Low-level input current	$V_{DD} = 5.5\text{ V}$, $V_I = -0.3\text{ V}$			1.2	μA	
I_{DD}	Supply current	$V_{DD} = 2.5\text{ V to }5.5\text{ V}$, no load, SHUTDOWN = 2 V		1.7	2	mA	
$I_{DD(SD)}$	Supply current in shutdown mode	SHUTDOWN = 0.8 V, $V_{DD} = 2.5\text{ V to }5.5\text{ V}$, no load		0.01	0.9	μA	

OPERATING CHARACTERISTICS
 $T_A = 25^\circ\text{C}$, Gain = 1 V/V, $R_L = 8\ \Omega$

PARAMETER		TEST CONDITIONS	MIN	TYP	MAX	UNIT
P_O	Output power	THD + N = 1%, $f = 1\text{ kHz}$	$V_{DD} = 5\text{ V}$		1.25	W
			$V_{DD} = 3.6\text{ V}$		0.63	
			$V_{DD} = 2.5\text{ V}$		0.3	
THD+N	Total harmonic distortion plus noise		$V_{DD} = 5\text{ V}$, $P_O = 1\text{ W}$, $f = 1\text{ kHz}$		0.06%	
			$V_{DD} = 3.6\text{ V}$, $P_O = 0.5\text{ W}$, $f = 1\text{ kHz}$		0.07%	
			$V_{DD} = 2.5\text{ V}$, $P_O = 200\text{ mW}$, $f = 1\text{ kHz}$		0.08%	
k_{SVR}	Supply ripple rejection ratio	$C_{(BYPASS)} = 0.47\ \mu\text{F}$, $V_{DD} = 3.6\text{ V to }5.5\text{ V}$, Inputs ac-grounded with $C_I = 2\ \mu\text{F}$	$f = 217\text{ Hz to }2\text{ kHz}$, $V_{RIPPLE} = 200\text{ mV}_{PP}$		-87	dB
		$C_{(BYPASS)} = 0.47\ \mu\text{F}$, $V_{DD} = 2.5\text{ V to }3.6\text{ V}$, Inputs ac-grounded with $C_I = 2\ \mu\text{F}$	$f = 217\text{ Hz to }2\text{ kHz}$, $V_{RIPPLE} = 200\text{ mV}_{PP}$		-82	
		$C_{(BYPASS)} = 0.47\ \mu\text{F}$, $V_{DD} = 2.5\text{ V to }5.5\text{ V}$, Inputs ac-grounded with $C_I = 2\ \mu\text{F}$	$f = 40\text{ Hz to }20\text{ kHz}$, $V_{RIPPLE} = 200\text{ mV}_{PP}$		≤ -74	
SNR	Signal-to-noise ratio	$V_{DD} = 5\text{ V}$, $P_O = 1\text{ W}$		104		dB
V_n	Output voltage noise	$f = 20\text{ Hz to }20\text{ kHz}$	No weighting		17	μV_{RMS}
			A weighting		13	
CMRR	Common-mode rejection ratio	$V_{DD} = 2.5\text{ V to }5.5\text{ V}$, $V_{ICM} = 200\text{ mV}_{PP}$	$f = 20\text{ Hz to }1\text{ kHz}$		≤ -85	dB
			$f = 20\text{ Hz to }20\text{ kHz}$		≤ -74	
Z_I	Input impedance			2		$\text{M}\Omega$
	Shutdown attenuation	$f = 20\text{ Hz to }20\text{ kHz}$, $R_F = R_I = 20\text{ k}\Omega$			-80	dB

TPA6203A1

SLOS364C–MARCH 2002–REVISED SEPTEMBER 2003

MicroStar Junior™ (GQV or ZQV) Package (TOP VIEW)

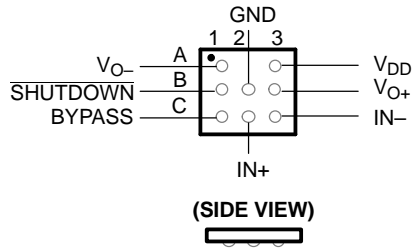

Terminal Functions

TERMINAL NAME	TERMINAL NO.	I/O	DESCRIPTION
BYPASS	C1	I	Mid-supply voltage. Connect a capacitor to GND for BYPASS voltage filtering. Bypass capacitor is optional.
GND	B2	I	High-current ground
IN-	C3	I	Negative differential input
IN+	C2	I	Positive differential input
SHUTDOWN	B1	I	Shutdown terminal. Pull this pin low (≤ 0.8 V) to place the device in shutdown and pull it high (≥ 2 V) for active mode.
V _{DD}	A3	I	Supply voltage terminal
V _{O+}	B3	O	Positive BTL output
V _{O-}	A1	O	Negative BTL output

TYPICAL CHARACTERISTICS

Table of Graphs

			FIGURE
P _O	Output power	vs Supply voltage	1
		vs Load resistance	2, 3
P _D	Power dissipation	vs Output power	4, 5
	Maximum ambient temperature	vs Power dissipation	6
	Total harmonic distortion + noise	vs Output power	7, 8
		vs Frequency	9, 10, 11, 12
		vs Common-mode input voltage	13
	Supply voltage rejection ratio	vs Frequency	14, 15, 16, 17
	Supply voltage rejection ratio	vs Common-mode input voltage	18
	GSM Power supply rejection	vs Time	19
	GSM Power supply rejection	vs Frequency	20
CMRR	Common-mode rejection ratio	vs Frequency	21
		vs Common-mode input voltage	22
	Closed loop gain/phase	vs Frequency	23
	Open loop gain/phase	vs Frequency	24
I _{DD}	Supply current	vs Supply voltage	25
		vs Shutdown voltage	26
	Start-up time	vs Bypass capacitor	27

TYPICAL CHARACTERISTICS

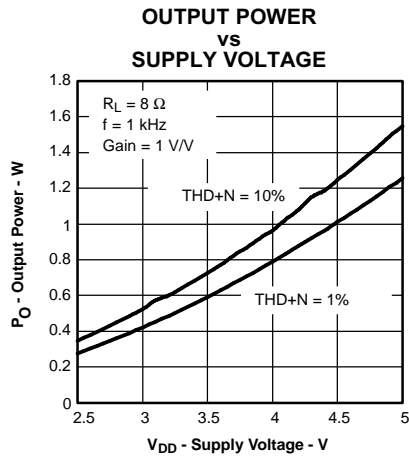

Figure 1.

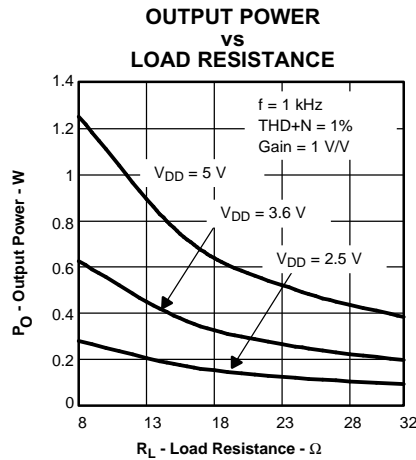

Figure 2.

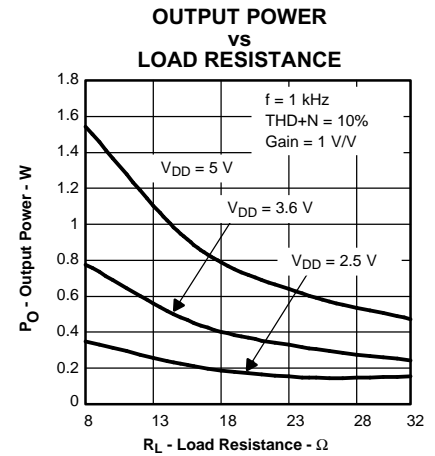

Figure 3.

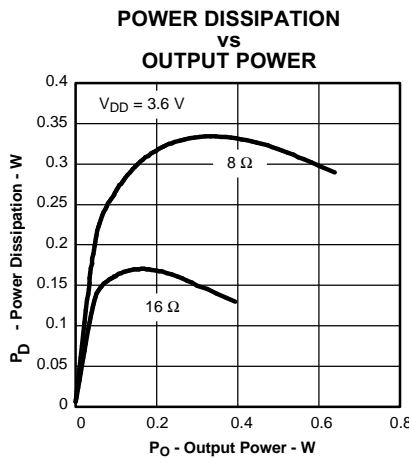

Figure 4.

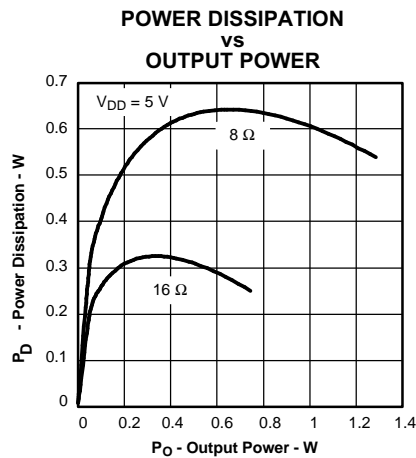

Figure 5.

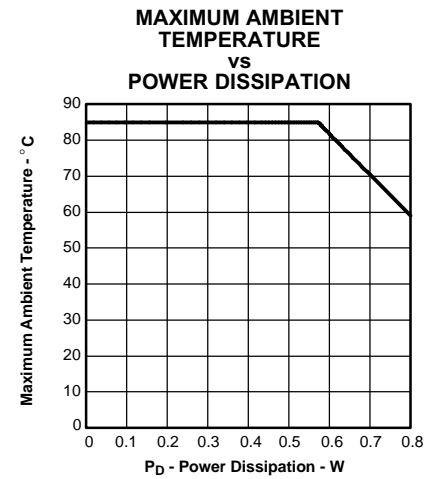

Figure 6.

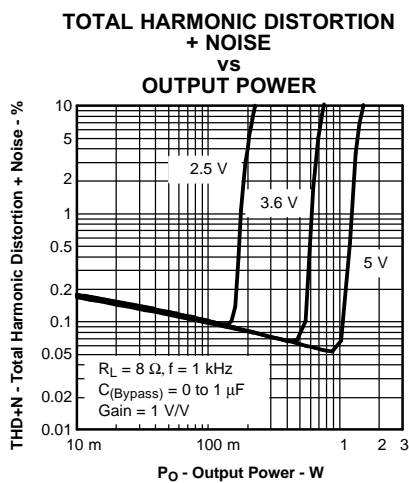

Figure 7.

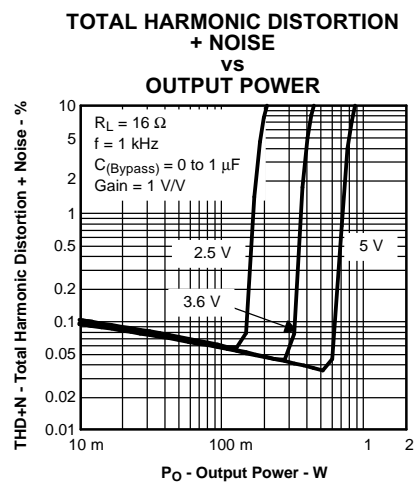

Figure 8.

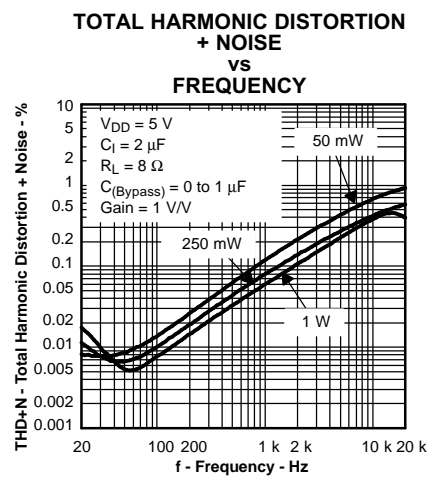

Figure 9.

TYPICAL CHARACTERISTICS (continued)

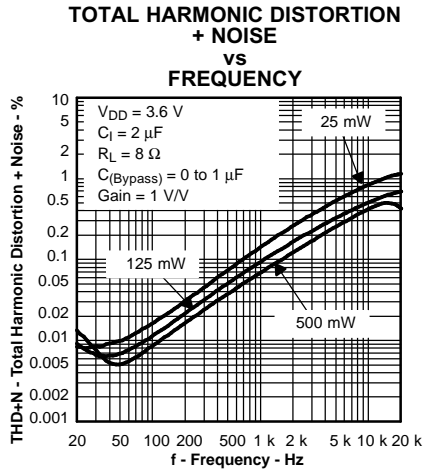

Figure 10.

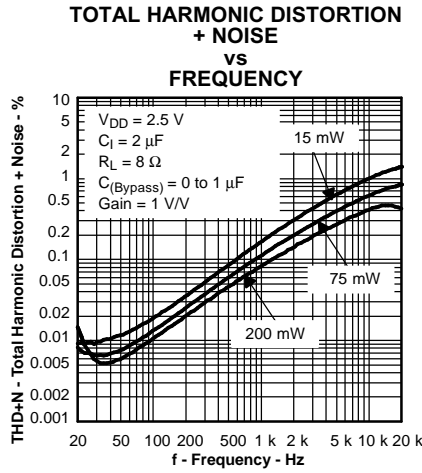

Figure 11.

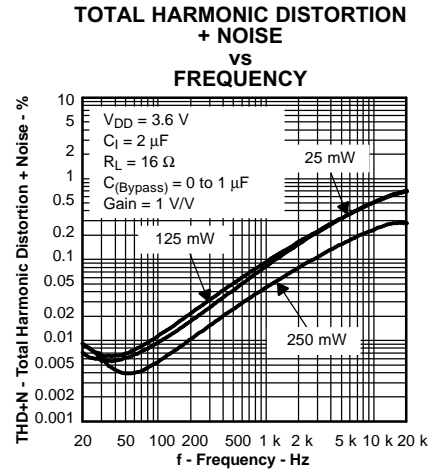

Figure 12.

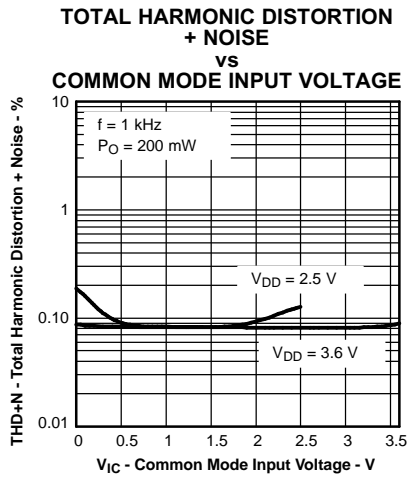

Figure 13.

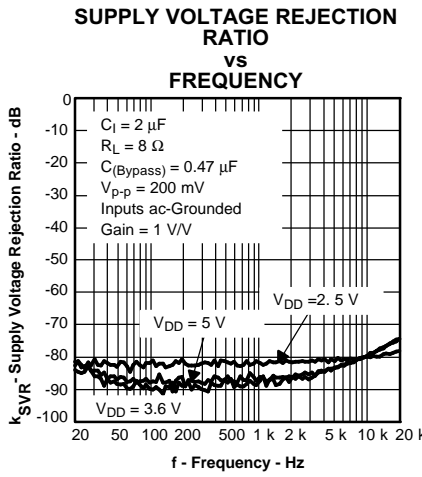

Figure 14.

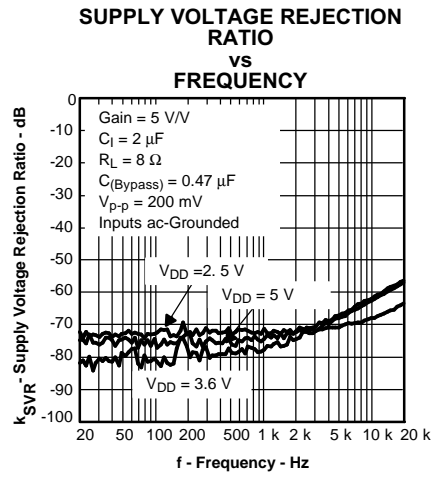

Figure 15.

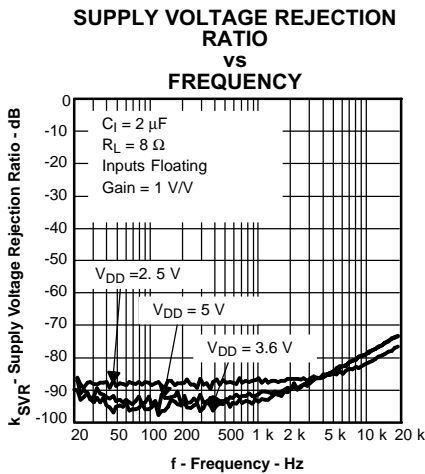

Figure 16.

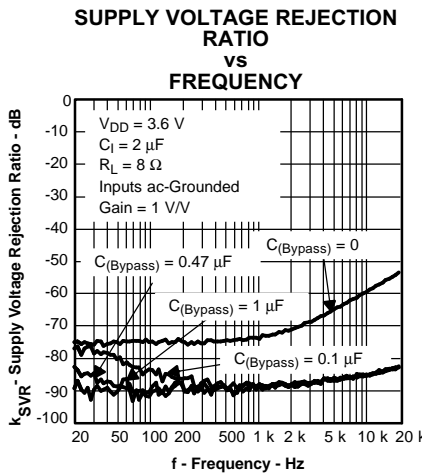

Figure 17.

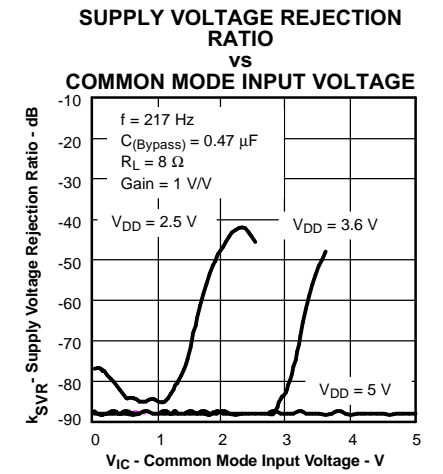

Figure 18.

TYPICAL CHARACTERISTICS (continued)

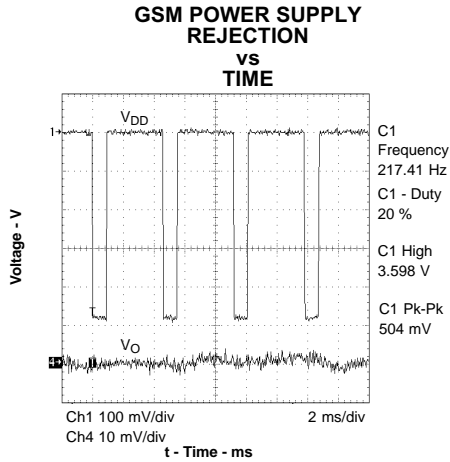

Figure 19.

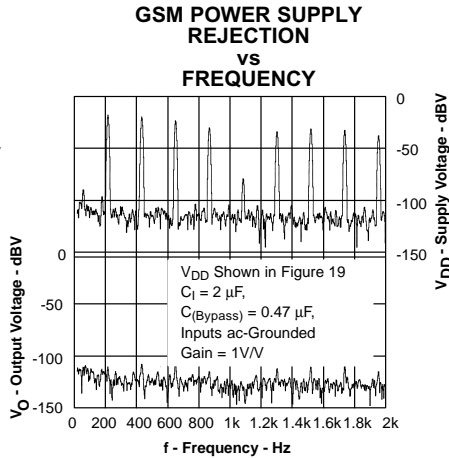

Figure 20.

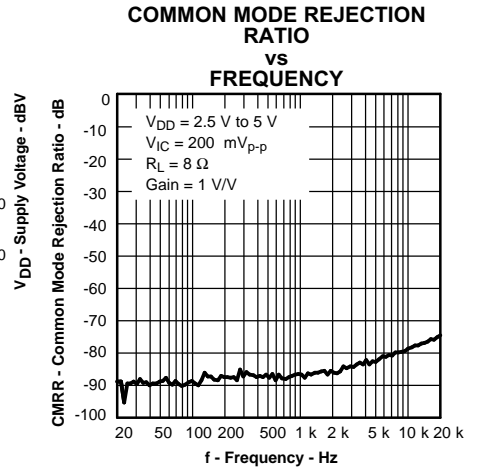

Figure 21.

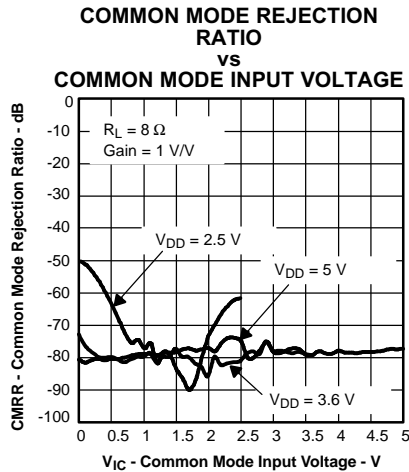

Figure 22.

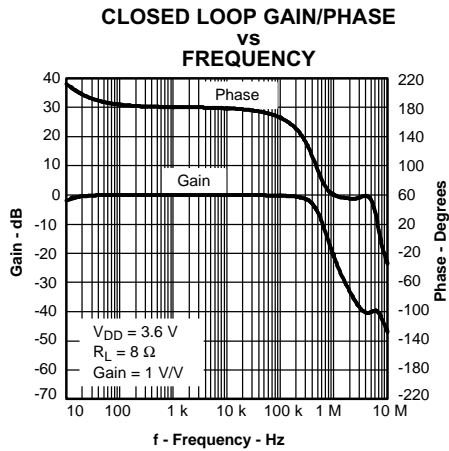

Figure 23.

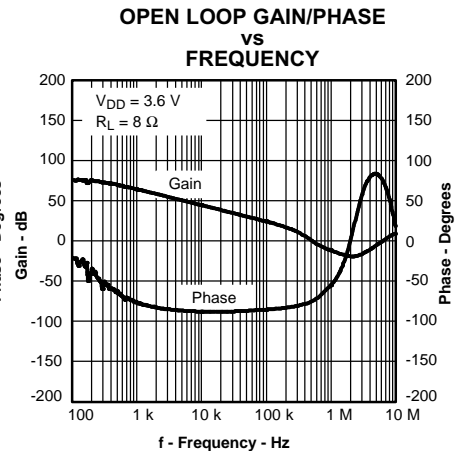

Figure 24.

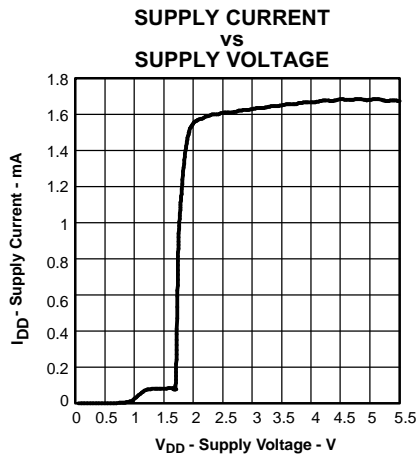

Figure 25.

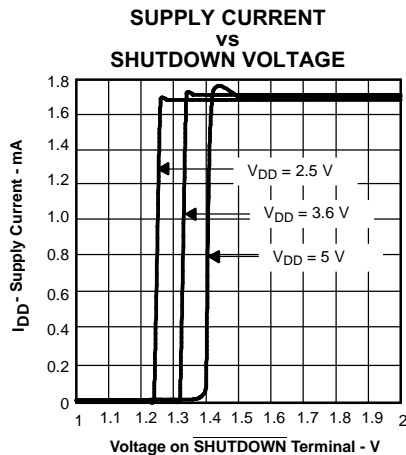
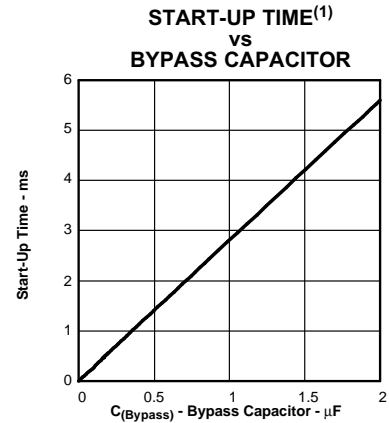

Figure 26.



(1) Start-Up time is the time it takes (from a low-to-high transition on SHUTDOWN) for the gain of the amplifier to reach -3 dB of the final gain.

Figure 27.

APPLICATION INFORMATION

FULLY DIFFERENTIAL AMPLIFIER

The TPA6203A1 is a fully differential amplifier with differential inputs and outputs. The fully differential amplifier consists of a differential amplifier and a common-mode amplifier. The differential amplifier ensures that the amplifier outputs a differential voltage that is equal to the differential input times the gain. The common-mode feedback ensures that the common-mode voltage at the output is biased around $V_{DD}/2$ regardless of the common-mode voltage at the input.

Advantages of Fully Differential Amplifiers

- Input coupling capacitors not required: A fully differential amplifier with good CMRR, like the TPA6203A1, allows the inputs to be biased at voltage other than mid-supply. For example, if a DAC has mid-supply lower than the mid-supply of the TPA6203A1, the common-mode feedback circuit adjusts for that, and the TPA6203A1 outputs are still biased at mid-supply of the TPA6203A1. The inputs of the TPA6203A1 can be biased from 0.5 V to $V_{DD} - 0.8$ V. If the inputs are biased outside of that range, input coupling capacitors are required.
- Mid-supply bypass capacitor, $C_{(BYPASS)}$, not required: The fully differential amplifier does not require a bypass capacitor. This is because any

shift in the mid-supply affects both positive and negative channels equally and cancels at the differential output. However, removing the bypass capacitor slightly worsens power supply rejection ratio (k_{SVR}), but a slight decrease of k_{SVR} may be acceptable when an additional component can be eliminated (see Figure 17).

- Better RF-immunity: GSM handsets save power by turning on and shutting off the RF transmitter at a rate of 217 Hz. The transmitted signal is picked-up on input and output traces. The fully differential amplifier cancels the signal much better than the typical audio amplifier.

APPLICATION SCHEMATICS

Figure 28 through Figure 30 show application schematics for differential and single-ended inputs. Typical values are shown in Table 1.

Table 1. Typical Component Values

COMPONENT	VALUE
R_I	10 k Ω
R_F	10 k Ω
$C_{(BYPASS)}^{(1)}$	0.22 μ F
C_S	1 μ F
C_I	0.22 μ F
(1) $C_{(BYPASS)}$ is optional	

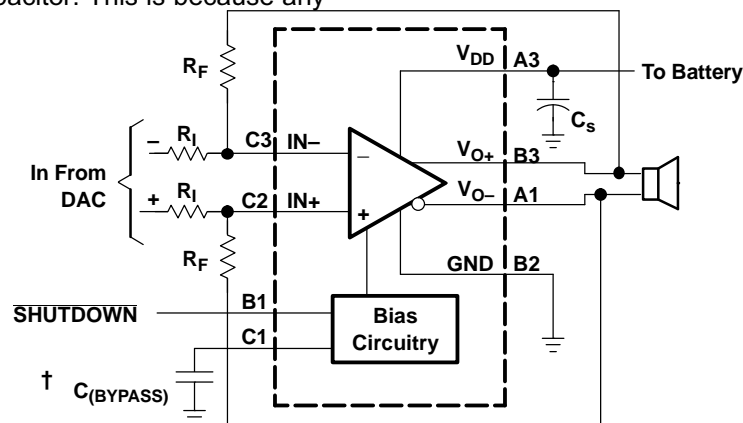

† $C_{(BYPASS)}$ is optional

Figure 28. Typical Differential Input Application Schematic

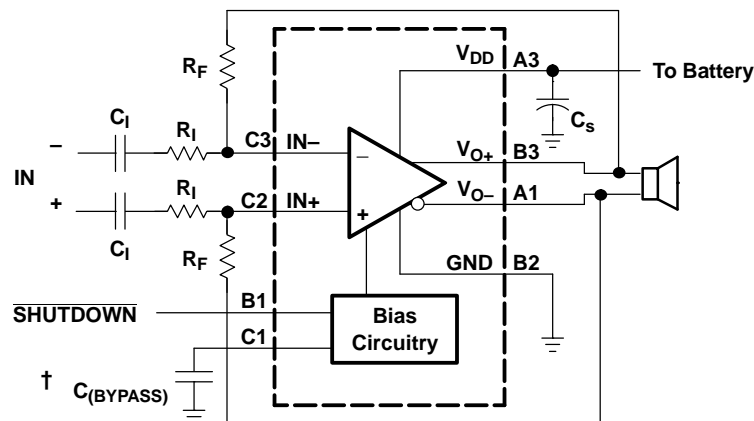

† C_(BYPASS) is optional

Figure 29. Differential Input Application Schematic Optimized With Input Capacitors

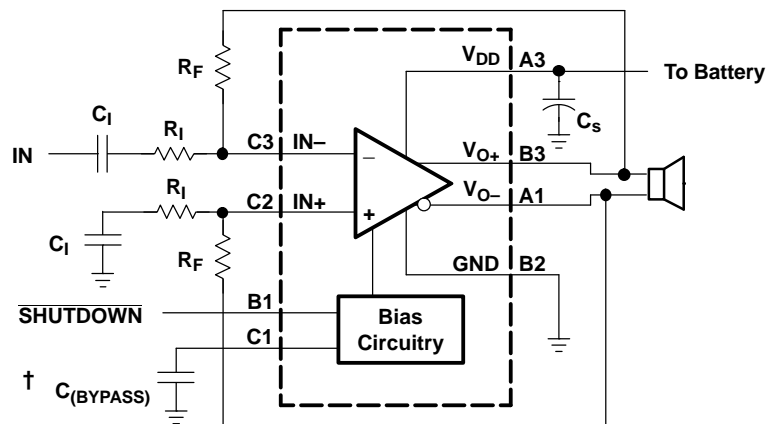

† C_(BYPASS) is optional

Figure 30. Single-Ended Input Application Schematic

Selecting Components

Resistors (R_F and R_I)

The input (R_I) and feedback resistors (R_F) set the gain of the amplifier according to Equation 1.

$$\text{Gain} = R_F/R_I \quad (1)$$

R_F and R_I should range from 1 kΩ to 100 kΩ. Most graphs were taken with R_F = R_I = 20 kΩ.

Resistor matching is very important in fully differential amplifiers. The balance of the output on the reference voltage depends on matched ratios of the resistors. CMRR, PSRR, and the cancellation of the second harmonic distortion diminishes if resistor mismatch occurs. Therefore, it is recommended to use 1% tolerance resistors or better to keep the performance optimized.

Bypass Capacitor (C_{BYPASS}) and Start-Up Time

The internal voltage divider at the BYPASS pin of this device sets a mid-supply voltage for internal references and sets the output common mode voltage to $V_{\text{DD}}/2$. Adding a capacitor to this pin filters any noise into this pin and increases the k_{SVR} . C_{BYPASS} also determines the rise time of $V_{\text{O+}}$ and $V_{\text{O-}}$ when the device is taken out of shutdown. The larger the capacitor, the slower the rise time. Although the output rise time depends on the bypass capacitor value, the device passes audio 4 μs after taken out of shutdown and the gain is slowly ramped up based on C_{BYPASS} .

Input Capacitor (C_{I})

The TPA6203A1 does not require input coupling capacitors if using a differential input source that is biased from 0.5 V to $V_{\text{DD}} - 0.8$ V. Use 1% tolerance or better gain-setting resistors if not using input coupling capacitors.

In the single-ended input application an input capacitor, C_{I} , is required to allow the amplifier to bias the input signal to the proper dc level. In this case, C_{I} and R_{I} form a high-pass filter with the corner frequency determined in Equation 2.

$$f_{\text{c}} = \frac{1}{2\pi R_{\text{I}} C_{\text{I}}} \quad (2)$$

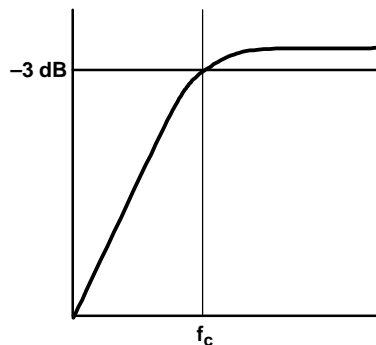

The value of C_{I} is important to consider as it directly affects the bass (low frequency) performance of the circuit. Consider the example where R_{I} is 10 k Ω and the specification calls for a flat bass response down to 100 Hz. Equation 2 is reconfigured as Equation 3.

$$C_{\text{I}} = \frac{1}{2\pi R_{\text{I}} f_{\text{c}}} \quad (3)$$

In this example, C_{I} is 0.16 μF , so one would likely choose a value in the range of 0.22 μF to 0.47 μF . A further consideration for this capacitor is the leakage path from the input source through the input network (R_{I} , C_{I}) and the feedback resistor (R_{F}) to the load. This leakage current creates a dc offset voltage at the input to the amplifier that reduces useful headroom, especially in high gain applications. For this reason, a ceramic capacitor is the best choice. When polarized capacitors are used, the positive side of the capacitor should face the amplifier input in most applications, as the dc level there is held at $V_{\text{DD}}/2$, which is likely higher than the source dc level. It is important to confirm the capacitor polarity in the application.

Decoupling Capacitor (C_{S})

The TPA6203A1 is a high-performance CMOS audio amplifier that requires adequate power supply decoupling to ensure the output total harmonic distortion (THD) is as low as possible. Power supply decoupling also prevents oscillations for long lead lengths between the amplifier and the speaker. For higher frequency transients, spikes, or digital hash on the line, a good low equivalent-series-resistance (ESR) ceramic capacitor, typically 0.1 μF to 1 μF , placed as close as possible to the device V_{DD} lead works best. For filtering lower frequency noise signals, a 10- μF or greater capacitor placed near the audio power amplifier also helps, but is not required in most applications because of the high PSRR of this device.

USING LOW-ESR CAPACITORS

Low-ESR capacitors are recommended throughout this applications section. A real (as opposed to ideal) capacitor can be modeled simply as a resistor in series with an ideal capacitor. The voltage drop across this resistor minimizes the beneficial effects of the capacitor in the circuit. The lower the equivalent value of this resistance the more the real capacitor behaves like an ideal capacitor.

DIFFERENTIAL OUTPUT VERSUS SINGLE-ENDED OUTPUT

Figure 31 shows a Class-AB audio power amplifier (APA) in a fully differential configuration. The TPA6203A1 amplifier has differential outputs driving both ends of the load. There are several potential benefits to this differential drive configuration, but initially consider power to the load. The differential drive to the speaker means that as one side is slewing up, the other side is slewing down, and vice versa. This in effect doubles the voltage swing on the load as compared to a ground referenced load. Plugging $2 \times V_{O(PP)}$ into the power equation, where voltage is squared, yields $4\times$ the output power from the same supply rail and load impedance (see Equation 4).

$$V_{(rms)} = \frac{V_{O(PP)}}{2\sqrt{2}}$$

$$Power = \frac{V_{(rms)}^2}{R_L} \tag{4}$$

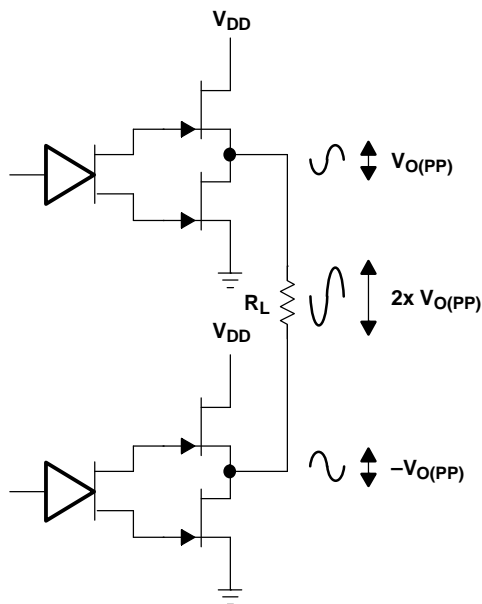

Figure 31. Differential Output Configuration

In a typical wireless handset operating at 3.6 V, bridging raises the power into an 8-Ω speaker from a singled-ended (SE, ground reference) limit of 200 mW to 800 mW. In sound power that is a 6-dB improvement—which is loudness that can be heard. In addition to increased power there are frequency response concerns. Consider the single-supply SE configuration shown in Figure 32. A coupling capacitor is required to block the dc offset voltage from reaching the load. This capacitor can be quite large (approximately 33 μF to 1000 μF) so it tends to be expensive, heavy, occupy valuable PCB area, and have the additional drawback of limiting low-frequency performance of the system. This frequency-limiting effect is due to the high pass filter network created with the speaker impedance and the coupling capacitance and is calculated with Equation 5.

$$f_c = \frac{1}{2\pi R_L C_C} \tag{5}$$

For example, a 68-μF capacitor with an 8-Ω speaker would attenuate low frequencies below 293 Hz. The BTL configuration cancels the dc offsets, which eliminates the need for the blocking capacitors. Low-frequency performance is then limited only by the input network and speaker response. Cost and PCB space are also minimized by eliminating the bulky coupling capacitor.

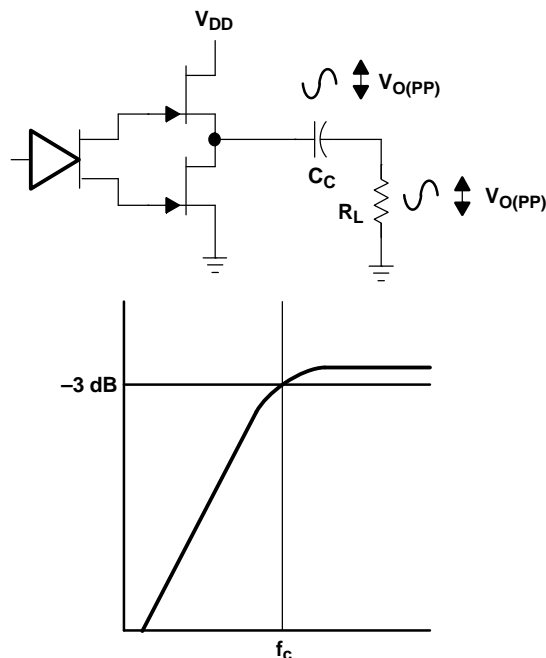

Figure 32. Single-Ended Output and Frequency Response

Increasing power to the load does carry a penalty of increased internal power dissipation. The increased dissipation is understandable considering that the BTL configuration produces 4× the output power of the SE configuration.

FULLY DIFFERENTIAL AMPLIFIER EFFICIENCY AND THERMAL INFORMATION

Class-AB amplifiers are inefficient. The primary cause of these inefficiencies is voltage drop across the output stage transistors. There are two components of the internal voltage drop. One is the headroom or dc voltage drop that varies inversely to output power. The second component is due to the sinewave nature of the output. The total voltage drop can be calculated by subtracting the RMS value of the output voltage from V_{DD} . The internal voltage drop multiplied by the average value of the supply current, $I_{DD(avg)}$, determines the internal power dissipation of the amplifier.

An easy-to-use equation to calculate efficiency starts out as being equal to the ratio of power from the power supply to the power delivered to the load. To accurately calculate the RMS and average values of power in the load and in the amplifier, the current and voltage waveform shapes must first be understood (see Figure 33).

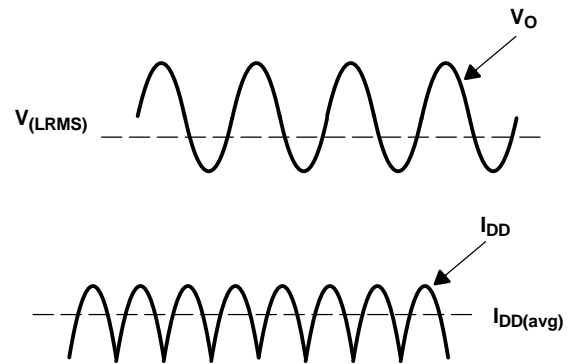

Figure 33. Voltage and Current Waveforms for BTL Amplifiers

Although the voltages and currents for SE and BTL are sinusoidal in the load, currents from the supply are very different between SE and BTL configurations. In an SE application the current waveform is a half-wave rectified shape, whereas in BTL it is a full-wave rectified waveform. This means RMS conversion factors are different. Keep in mind that for most of the waveform both the push and pull transistors are not on at the same time, which supports the fact that each amplifier in the BTL device only draws current from the supply for half the waveform. The following equations are the basis for calculating amplifier efficiency.

$$\text{Efficiency of a BTL amplifier} = \frac{P_L}{P_{SUP}}$$

where:

$$P_L = \frac{V_{L\text{rms}}^2}{R_L}, \text{ and } V_{LRMS} = \frac{V_P}{\sqrt{2}}, \text{ therefore, } P_L = \frac{V_P^2}{2R_L}$$

$$\text{and } P_{SUP} = V_{DD} I_{DD\text{avg}} \text{ and } I_{DD\text{avg}} = \frac{1}{\pi} \int_0^\pi \frac{V_P}{R_L} \sin(t) dt = \frac{1}{\pi} \times \frac{V_P}{R_L} [\cos(t)]_0^\pi = \frac{2V_P}{\pi R_L}$$

Therefore,

$$P_{SUP} = \frac{2V_{DD} V_P}{\pi R_L}$$

substituting P_L and P_{SUP} into equation 6,

$$\text{Efficiency of a BTL amplifier} = \frac{\frac{V_P^2}{2R_L}}{\frac{2V_{DD} V_P}{\pi R_L}} = \frac{\pi V_P}{4V_{DD}}$$

where:

$$V_P = \sqrt{2 P_L R_L}$$

- P_L = Power delivered to load
- P_{SUP} = Power drawn from power supply
- V_{LRMS} = RMS voltage on BTL load
- R_L = Load resistance
- V_P = Peak voltage on BTL load
- $I_{DD\text{avg}}$ = Average current drawn from the power supply
- V_{DD} = Power supply voltage
- η_{BTL} = Efficiency of a BTL amplifier

(6)

Therefore,

$$\eta_{\text{BTL}} = \frac{\pi \sqrt{2 P_L R_L}}{4 V_{\text{DD}}} \quad (7)$$

Table 2. Efficiency and Maximum Ambient Temperature vs Output Power in 5-V 8-Ω BTL Systems

Output Power (W)	Efficiency (%)	Internal Dissipation (W)	Power From Supply (W)	Max Ambient Temperature (°C)
0.25	31.4	0.55	0.75	62
0.50	44.4	0.62	1.12	54
1.00	62.8	0.59	1.59	58
1.25	70.2	0.53	1.78	65

Table 2 employs Equation 7 to calculate efficiencies for four different output power levels. Note that the efficiency of the amplifier is quite low for lower power levels and rises sharply as power to the load is increased resulting in a nearly flat internal power dissipation over the normal operating range. Note that the internal dissipation at full output power is less than in the half power range. Calculating the efficiency for a specific system is the key to proper power supply design. For a 1.25-W audio system with 8-Ω loads and a 5-V supply, the maximum draw on the power supply is almost 1.8 W.

A final point to remember about Class-AB amplifiers is how to manipulate the terms in the efficiency equation to the utmost advantage when possible. Note that in Equation 7, V_{DD} is in the denominator. This indicates that as V_{DD} goes down, efficiency goes up.

A simple formula for calculating the maximum power dissipated, P_{Dmax} , may be used for a differential output application:

$$P_{\text{Dmax}} = \frac{2 V_{\text{DD}}^2}{\pi^2 R_L} \quad (8)$$

P_{Dmax} for a 5-V, 8-Ω system is 634 mW.

The maximum ambient temperature depends on the heat sinking ability of the PCB system. The derating factor for the 2 mm x 2 mm Microstar Junior™ package is shown in the dissipation rating table. Converting this to θ_{JA} :

$$\theta_{\text{JA}} = \frac{1}{\text{Derating Factor}} = \frac{1}{0.0088} = 113^\circ\text{C/W} \quad (9)$$

Given θ_{JA} , the maximum allowable junction temperature, and the maximum internal dissipation, the maximum ambient temperature can be calculated with the following equation. The maximum recommended junction temperature for the TPA6203A1 is 125°C.

$$T_{\text{A Max}} = T_{\text{J Max}} - \theta_{\text{JA}} P_{\text{Dmax}} \\ = 125 - 113(0.634) = 53.3^\circ\text{C} \quad (10)$$

Equation 10 shows that the maximum ambient temperature is 53.3°C at maximum power dissipation with a 5-V supply.

Table 2 shows that for most applications no airflow is required to keep junction temperatures in the specified range. The TPA6203A1 is designed with thermal protection that turns the device off when the junction temperature surpasses 150°C to prevent damage to the IC. Also, using more resistive than 8-Ω speakers dramatically increases the thermal performance by reducing the output current.

PCB LAYOUT

In making the pad size for the BGA balls, it is recommended that the layout use solder-mask-defined (SMD) land. With this method, the copper pad is made larger than the desired land area, and the opening size is defined by the opening in the solder mask material. The advantages normally associated with this technique include more closely controlled size and better copper adhesion to the laminate. Increased copper also increases the thermal performance of the IC. Better size control is the result of photo imaging the stencils for masks. Small plated vias should be placed near the center ball connecting ball B2 to the ground plane. Added plated vias and ground plane act as a heatsink and increase the thermal performance of the device. Figure 34 shows the appropriate diameters for a 2 mm X 2 mm MicroStar Junior™ BGA layout.

It is very important to keep the TPA6203A1 external components very close to the TPA6203A1 to limit noise pickup. The TPA6203A1 evaluation module (EVM) layout is shown in the next section as a layout example.

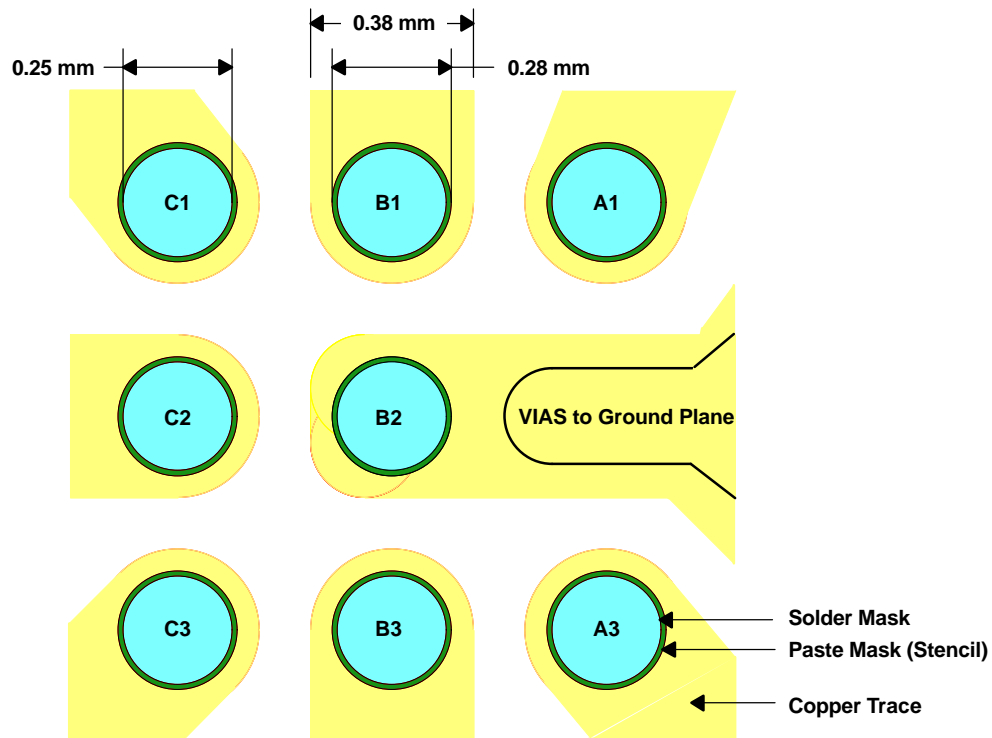

Figure 34. MicroStar Junior™ BGA Recommended Layout

TPA6203A1 EVM PCB Layers

The following illustrations depict the TPA6203A1 EVM PCB layers and silkscreen. These drawings are enlarged to better show the routing. Gerber plots can be obtained from any TI sales office.

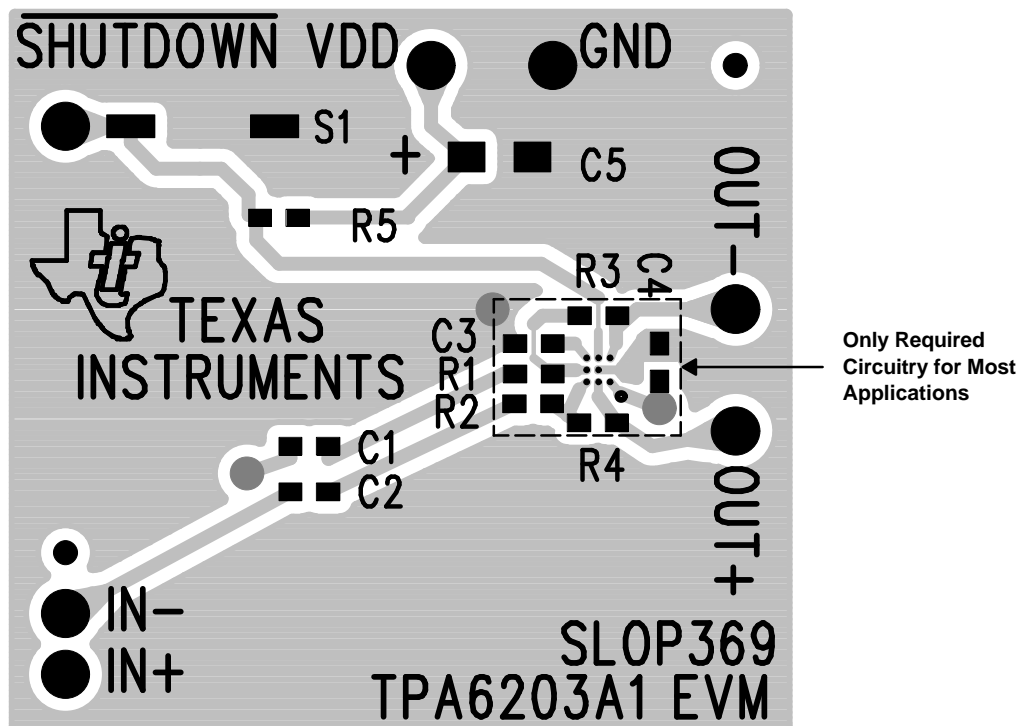

Figure 35. TPA6203A1 EVM Top Layer (Not to scale)

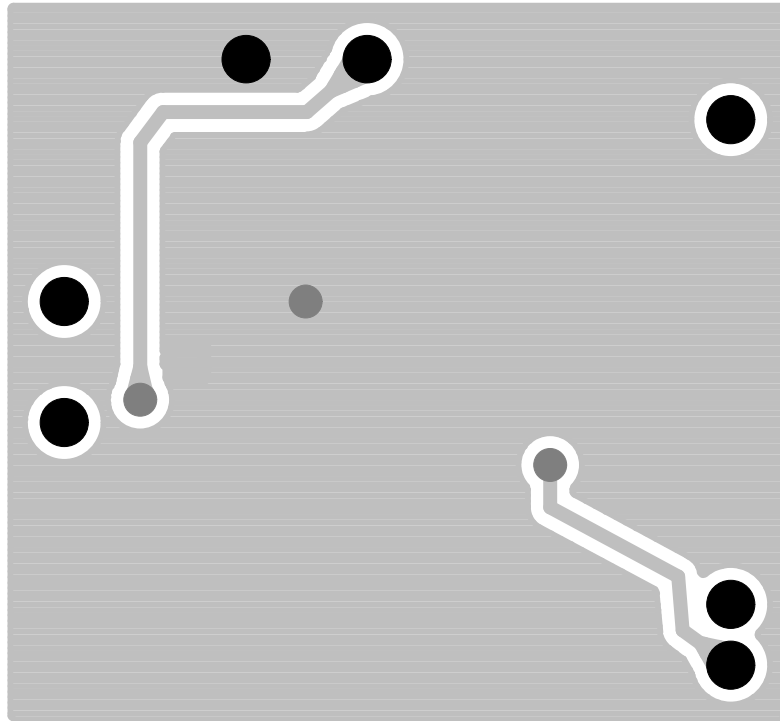
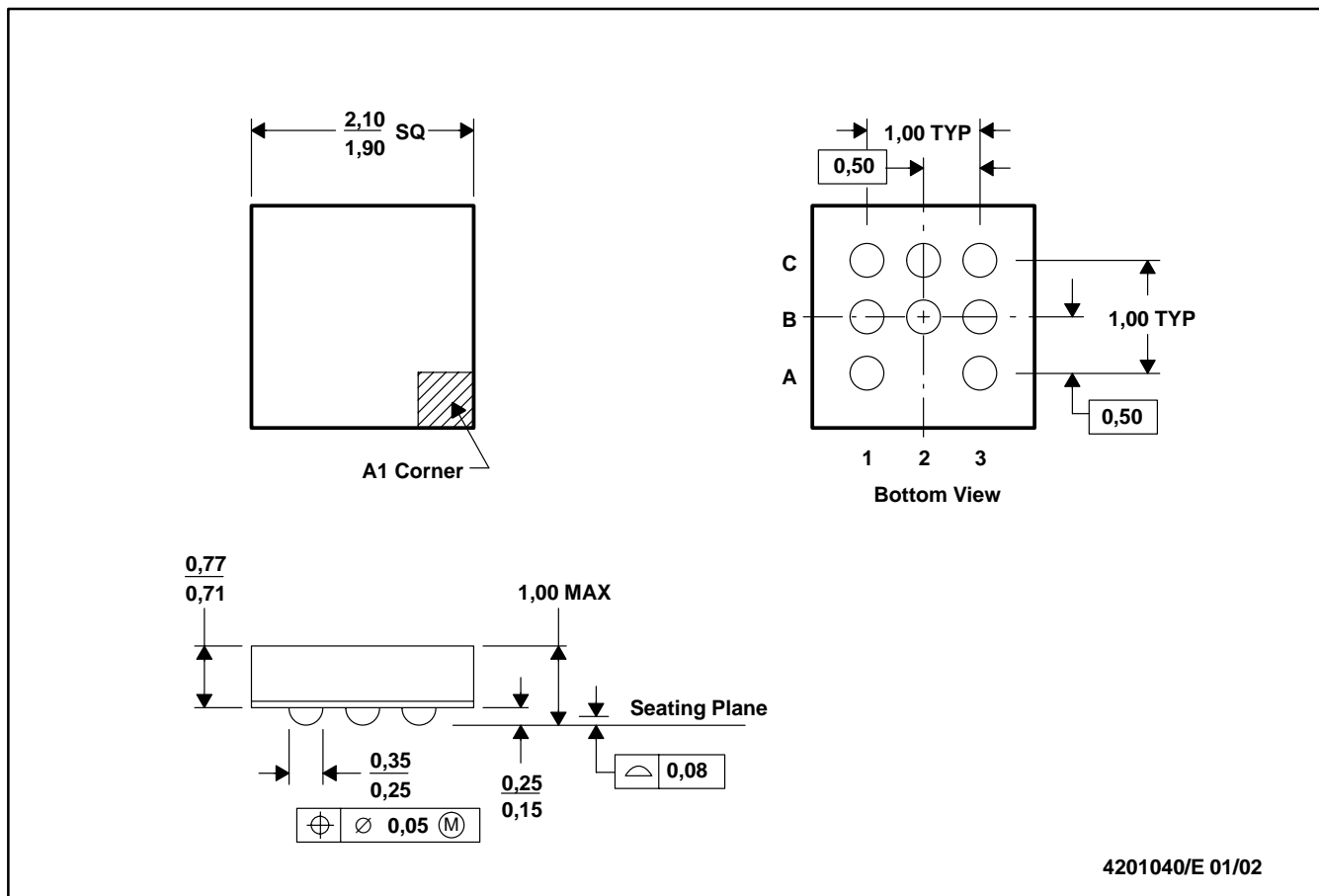

Figure 36. TPA6203A1 EVM Bottom Layer (Not to scale)

GQV (S-PBGA-N8)

PLASTIC BALL GRID ARRAY



- NOTES: A. All linear dimensions are in millimeters.
 B. This drawing is subject to change without notice.
 C. MicroStar Junior™ configuration
 D. Falls within JEDEC MO-225

MicroStar Junior is a trademark of Texas Instruments.



ZQV (S-PBGA-N8)

PLASTIC BALL GRID ARRAY

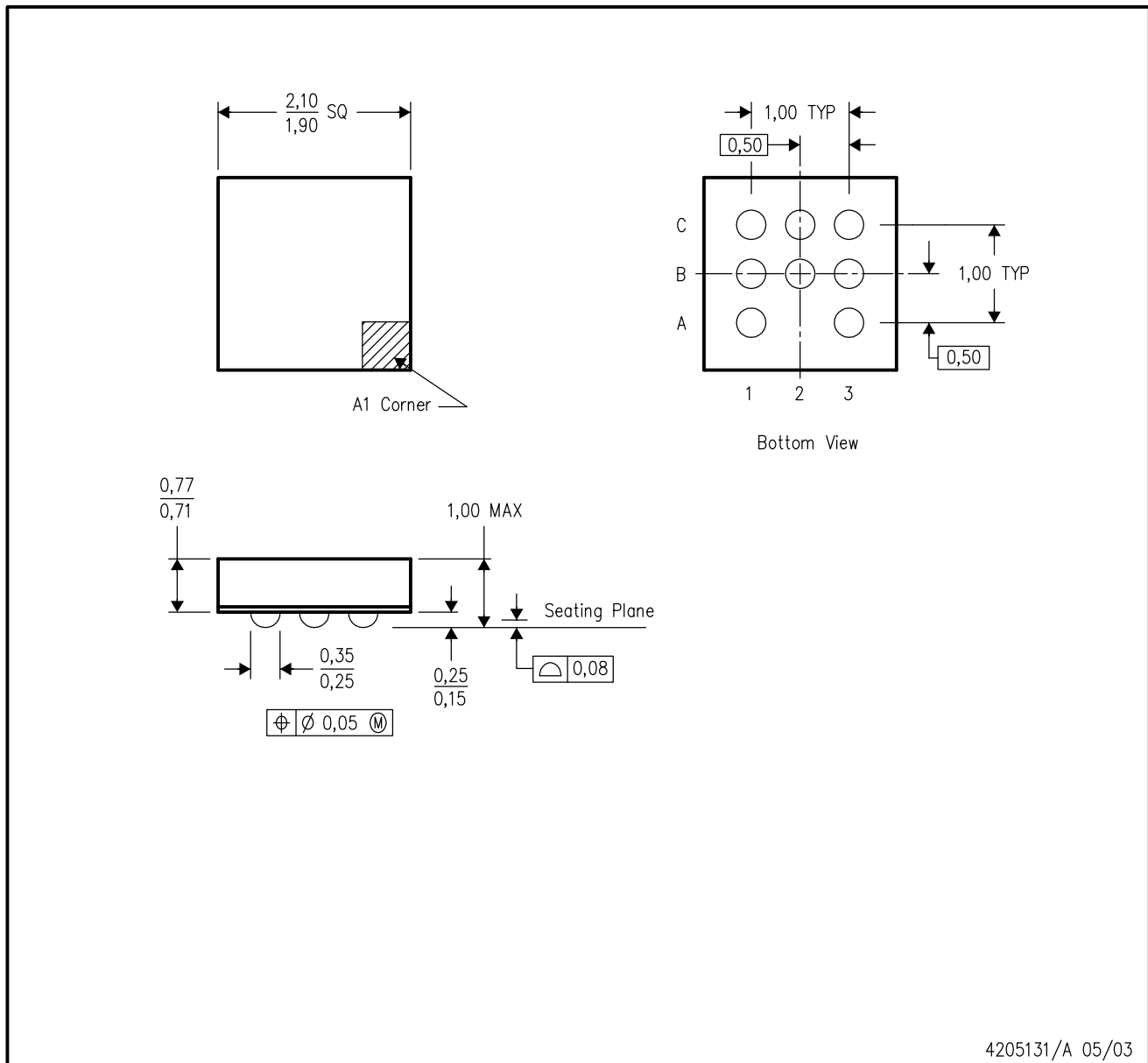

- NOTES:
- All linear dimensions are in millimeters.
 - This drawing is subject to change without notice.
 - MicroStar Junior configuration
 - Falls within JEDEC MO-225
 - This package is lead-free.

IMPORTANT NOTICE

Texas Instruments Incorporated and its subsidiaries (TI) reserve the right to make corrections, modifications, enhancements, improvements, and other changes to its products and services at any time and to discontinue any product or service without notice. Customers should obtain the latest relevant information before placing orders and should verify that such information is current and complete. All products are sold subject to TI's terms and conditions of sale supplied at the time of order acknowledgment.

TI warrants performance of its hardware products to the specifications applicable at the time of sale in accordance with TI's standard warranty. Testing and other quality control techniques are used to the extent TI deems necessary to support this warranty. Except where mandated by government requirements, testing of all parameters of each product is not necessarily performed.

TI assumes no liability for applications assistance or customer product design. Customers are responsible for their products and applications using TI components. To minimize the risks associated with customer products and applications, customers should provide adequate design and operating safeguards.

TI does not warrant or represent that any license, either express or implied, is granted under any TI patent right, copyright, mask work right, or other TI intellectual property right relating to any combination, machine, or process in which TI products or services are used. Information published by TI regarding third-party products or services does not constitute a license from TI to use such products or services or a warranty or endorsement thereof. Use of such information may require a license from a third party under the patents or other intellectual property of the third party, or a license from TI under the patents or other intellectual property of TI.

Reproduction of information in TI data books or data sheets is permissible only if reproduction is without alteration and is accompanied by all associated warranties, conditions, limitations, and notices. Reproduction of this information with alteration is an unfair and deceptive business practice. TI is not responsible or liable for such altered documentation.

Resale of TI products or services with statements different from or beyond the parameters stated by TI for that product or service voids all express and any implied warranties for the associated TI product or service and is an unfair and deceptive business practice. TI is not responsible or liable for any such statements.

Following are URLs where you can obtain information on other Texas Instruments products and application solutions:

Products		Applications	
Amplifiers	amplifier.ti.com	Audio	www.ti.com/audio
Data Converters	dataconverter.ti.com	Automotive	www.ti.com/automotive
DSP	dsp.ti.com	Broadband	www.ti.com/broadband
Interface	interface.ti.com	Digital Control	www.ti.com/digitalcontrol
Logic	logic.ti.com	Military	www.ti.com/military
Power Mgmt	power.ti.com	Optical Networking	www.ti.com/opticalnetwork
Microcontrollers	microcontroller.ti.com	Security	www.ti.com/security
		Telephony	www.ti.com/telephony
		Video & Imaging	www.ti.com/video
		Wireless	www.ti.com/wireless

Mailing Address: Texas Instruments
Post Office Box 655303 Dallas, Texas 75265

Copyright © 2003, Texas Instruments Incorporated