

# Medium power transistor (−30V, −0.5A)

## 2SA2047

### ●Features

- 1) High speed switching. ( $T_f$  : Typ. : 40ns at  $I_c = -500\text{mA}$ )
- 2) Low saturation voltage, typically  
(Typ. :  $-150\text{mV}$  at  $I_c = -100\text{A}$ ,  $I_B = -100\text{mA}$ )
- 3) Strong discharge power for inductive load and capacitance load.
- 4) Complements the 2SC5729

### ●Applications

Small signal low frequency amplifier  
High speed switching

### ●Structure

PNP Silicon epitaxial planar transistor

### ●Packaging specifications

Type	Package	Taping
	Code	T106
	Basic ordering unit (pieces)	3000
2SA2047		○

### ●Absolute maximum ratings ( $T_a=25^\circ\text{C}$ )

Parameter	Symbol	Limits	Unit
Collector-base voltage	$V_{CB0}$	−30	V
Collector-emitter voltage	$V_{CE0}$	−30	V
Emitter-base voltage	$V_{EB0}$	−6	V
Collector current	$I_c$	−0.5	A
	$I_{CP}$	−1.0	A *1
Power dissipation	$P_C$	200	mW *2
Junction temperature	$T_j$	150	°C
Range of storage temperature	$T_{stg}$	−55~+150	°C

\*1  $P_w=10\text{ms}$

\*2 Each terminal mounted on a recommended land

### ●External dimensions (Units : mm)

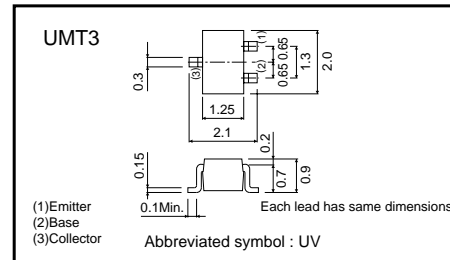

Transistor

●Electrical characteristics (Ta=25°C)

Parameter	Symbol	Min.	Typ.	Max.	Unit	Conditions
Collector-base breakdown voltage	BV <sub>CB0</sub>	-30	-	-	V	I <sub>C</sub> =-100μA
Collector-emitter breakdown voltage	BV <sub>CEO</sub>	-30	-	-	V	I <sub>C</sub> =-1mA
Emitter-base breakdown voltage	BV <sub>EB0</sub>	-6	-	-	V	I <sub>E</sub> =-100μA
Collector cut-off current	I <sub>CBO</sub>	-	-	-1.0	μA	V <sub>CB</sub> =-20V
Emitter cut-off current	I <sub>EBO</sub>	-	-	-1.0	μA	V <sub>EB</sub> =-4V
Collector-emitter saturation voltage	V <sub>CE(sat)</sub>	-	-150	-300	mV	I <sub>C</sub> =-100mA, I <sub>B</sub> =-10mA
DC current gain	h <sub>FE</sub>	120	-	390	-	V <sub>CE</sub> =-2V, I <sub>C</sub> =-50mA
Transition frequency	f <sub>r</sub>	-	400	-	MHz	V <sub>CE</sub> =-10V, I <sub>E</sub> =100mA, f=10MHz
Collector output capacitance	C <sub>ob</sub>	-	10	-	pF	V <sub>CB</sub> =-10V, I <sub>E</sub> =0A, f=1MHz
Turn-on time	T <sub>on</sub>	-	40	-	ns	I <sub>C</sub> =-500mA
Storage time	T <sub>stg</sub>	-	100	-	ns	I <sub>B1</sub> =-50mA
Fall time	T <sub>f</sub>	-	40	-	ns	I <sub>B2</sub> =-50mA
						V <sub>CC</sub> =-25V

●h<sub>FE</sub> RANK

Q	R
120-270	180-390

●Electrical characteristic curves

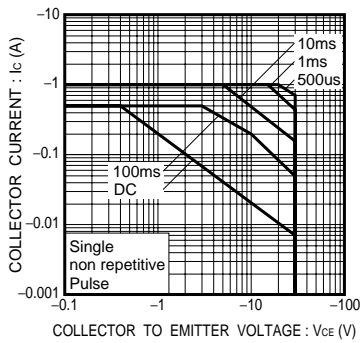

Fig.1 Safe Operating Area

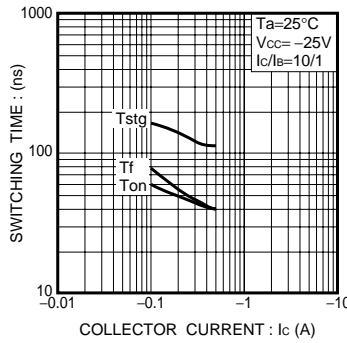

Fig.2 Switching Time

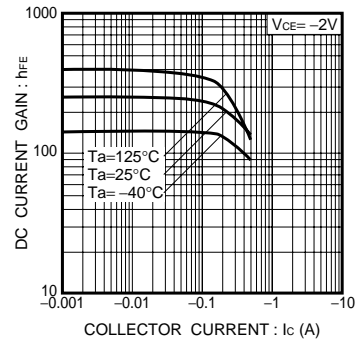

Fig.3 DC Current Gain vs. Collector Current (I)

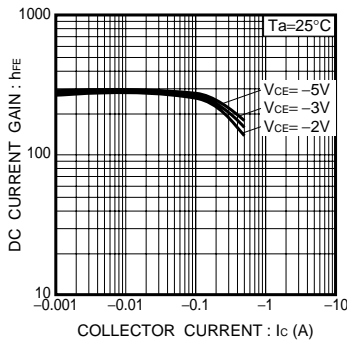

Fig.4 DC Current Gain vs. Collector Current (II)

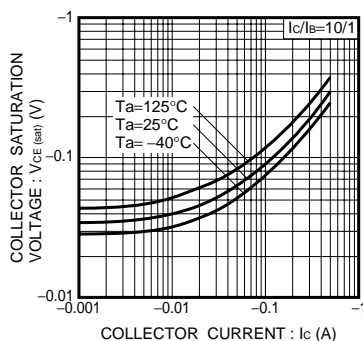

Fig.5 Collector-Emitter Saturation Voltage vs. Collector Current (I)

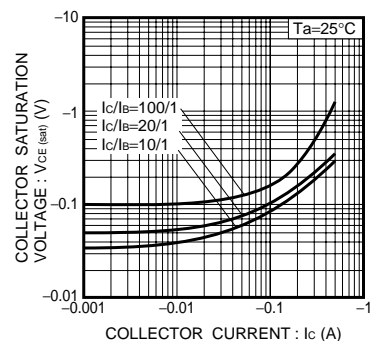

Fig.6 Collector-Emitter Saturation Voltage vs. Collector Current (II)

Transistor

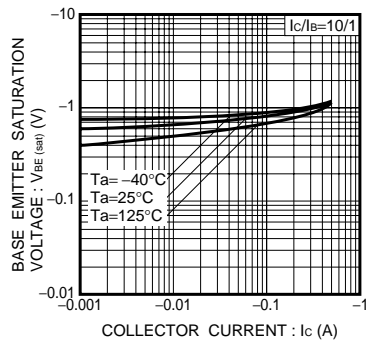

Fig.7 Base-Emitter Saturation Voltage vs. Collector Current

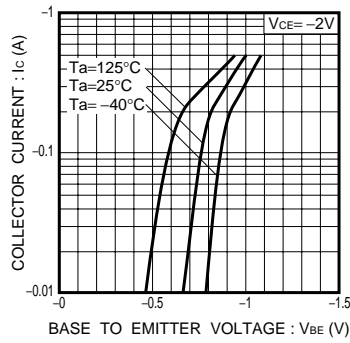

Fig.8 Grounded Emitter Propagation Characteristics

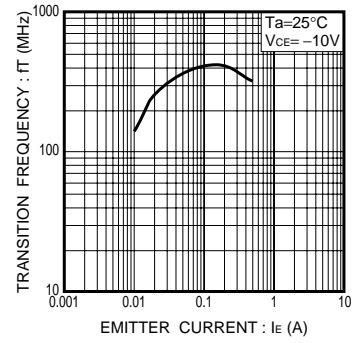

Fig.9 Transition Frequency

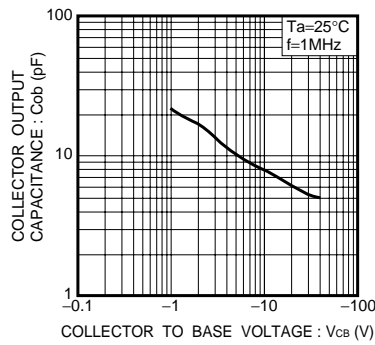
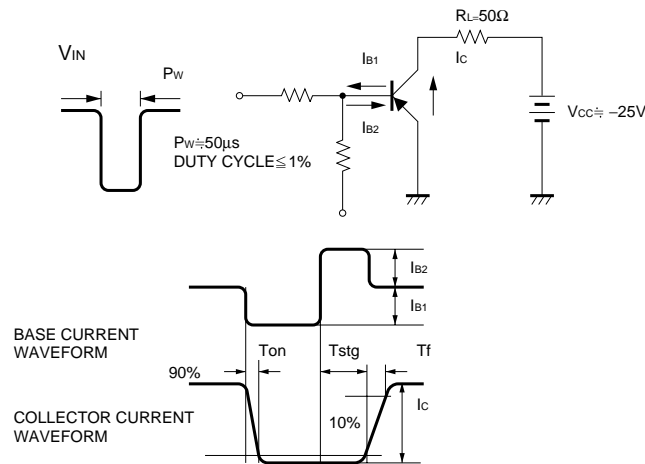

Fig.10 Collector Output Capacitance

●Switching characteristics measurement circuits



This datasheet has been download from:

[www.datasheetcatalog.com](http://www.datasheetcatalog.com)

Datasheets for electronics components.