

TPD1039F

Low-Side Power Switch for Motor, Solenoid and Lamp Drivers

The TPD1039F is a monolithic power IC intended for low-side load switching applications. The output has a vertical MOSFET, and the input can be directly driven from CMOS or TTL logic (e.g., an MPU). The TPD1039F provides intelligent protection functions.

Features

- A structure that incorporates control circuitry and a vertical power MOSFET on a single chip.
- Can be directly driven from a microprocessor, a CMOS logic IC, etc.
- Overvoltage, overtemperature and overcurrent protections
- Low ON-resistance: $R_{DS(ON)} = 0.25 \Omega$ (max) (@ $V_{IN} = 5 V$, $I_D = 1 A$, $T_{ch} = 25^\circ C$)
- Housed in the 8-pin SOP package and supplied in embossed carrier tape.

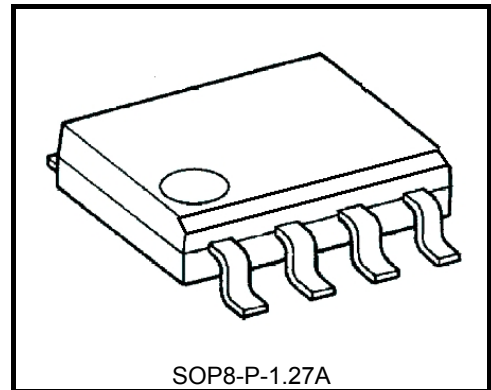

Weight: 0.08 g (typ.)

Pin Assignment (top view)

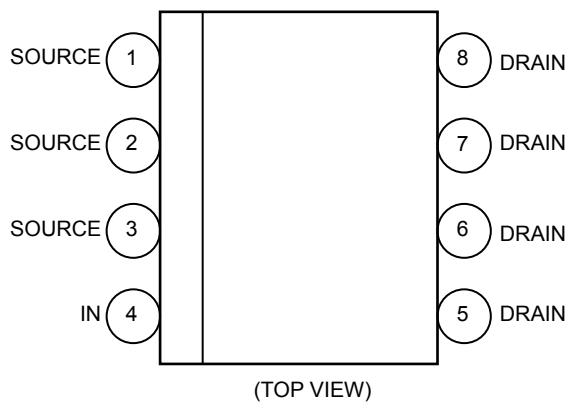

Marking

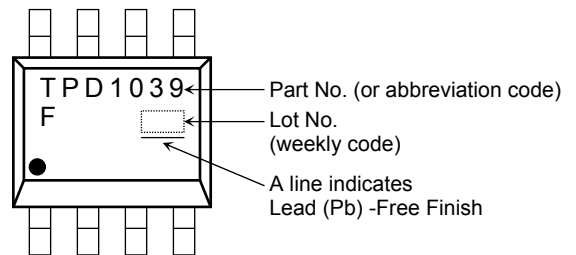

Note: This product has a MOS structure and is sensitive to electrostatic discharge.

Block Diagram

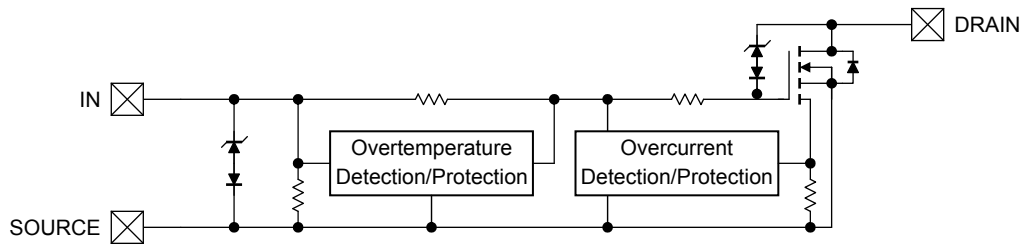

Pin Description

Pin No.	Symbol	Pin Description
1, 2, 3	SOURCE	Source (ground) pins.
4	IN	Input pin. This pin is connected to a pull-down resistor internally, so that even if the input is open-circuited, the output never turns on inadvertently.
5, 6, 7, 8	DRAIN	Drain pins. The output current is limited to 5 A (typ.) even if an excessive current flows into a device due to an in-rush current of a lamp or load short-circuit.

Timing Chart

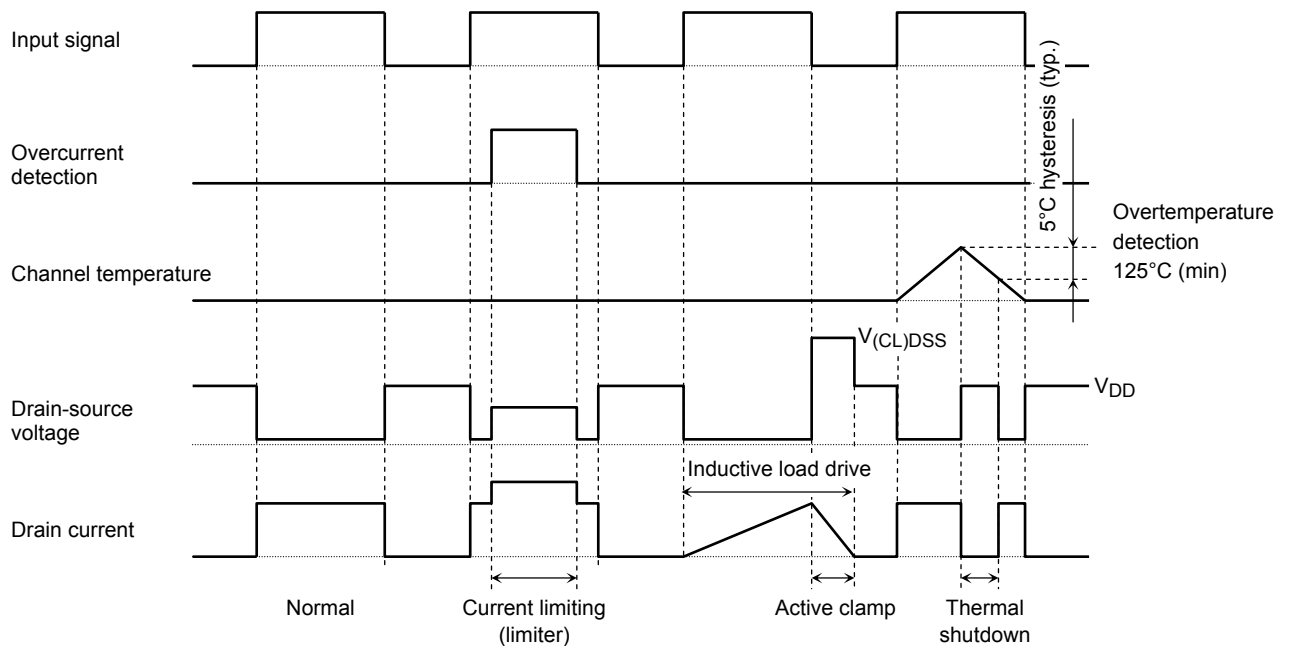

Truth Table

V_{IN}	V_{DS}	Output State	Operating State
L	H	Off	Normal
H	L	On	
L	H	Off	Load short-circuited
H	H	Current limiting(limiter)	
L	H	Off	Overtemperature
H	H	Off	

Absolute Maximum Ratings (Ta = 25°C)

Characteristics	Symbol	Rating	Unit
Drain-source voltage	V _{DS} (DC)	45	V
Drain current	I _D (DC)	1.5	A
Input voltage	V _{IN}	-0.5 to 6	V
Power dissipation (Note 2-a)	P _{D(1)}	1.1	W
Power dissipation (Note 2-b)	P _{D(2)}	0.425	W
Single pulse active clamp capability (Note 3)	E _{AS}	20	mJ
Active clamp current	I _{AR}	1.5	A
Repetitive active clamp capability (Note 2-a) (Note 4)	E _{AR}	0.11	mJ
Operating temperature	T _{opr}	-40 to 85	°C
Channel temperature	T _{ch}	150 (Note 5)	°C
Storage temperature	T _{stg}	-55 to 150	°C

Note 1: Using continuously under heavy loads (e.g. the application of high temperature/current/voltage and the significant change in temperature, etc.) may cause this product to decrease in the reliability significantly even if the operating conditions (i.e. operating temperature/current/voltage, etc.) are within the absolute maximum ratings and the operating ranges.

Please design the appropriate reliability upon reviewing the Toshiba Semiconductor Reliability Handbook (“Handling Precautions”/“Derating Concept and Methods”) and individual reliability data (i.e. reliability test report and estimated failure rate, etc).

Thermal Characteristics

Characteristics	Symbol	Rating	Unit
Thermal resistance, channel to ambient	R _{th(ch-a)}	113.5 (Note 2-a)	°C /W
		294.0 (Note 2-b)	

Note 2:

2-a: glass epoxy board (a)

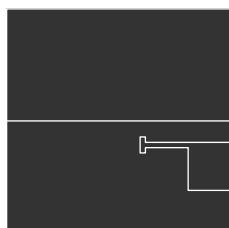

FR-4
25.4 × 25.4 × 0.8
(unit: mm)

2-b: glass epoxy board (b)

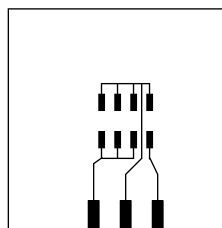

FR-4
25.4 × 25.4 × 0.8
(unit: mm)

Note 3: Active clamp capability (single pulse) test condition

V_{DD} = 25 V, T_{ch} = 25°C (initial), L = 10 mH, I_{AR} = 1.5 A, R_G = 25 Ω

Note 4: Repetitive rating: Pulse width limited by maximum channel temperature

Note 5: Overtemperature protection is tripped at a channel temperature of 125°C.

Ensure that the channel temperature, T_{ch}, does not exceed 125°C under the worst-case conditions.

Electrical Characteristics (T_{ch} = 25°C)

Characteristics	Symbol	Test Circuit	Test Condition	Min	Typ.	Max	Unit
Drain-source clamp voltage	V _{(CL)DSS}	-	V _{IN} = 0 V, I _D = 1 mA	45	-	-	V
High-level input voltage	V _{IH}	1	V _{DS} = 10 to 40 V, I _D ≥ 1 A	3.5	-	6	V
Low-level input voltage	V _{IL}	1	V _{DS} = 10 to 40 V, I _D ≤ 10 μA	-	-	0.8	
Drain cut-off current	I _{DSS}	-	V _{IN} = 0 V, V _{DS} = 40 V	-	-	10	μA
High-level input current	I _{IH}	-	V _{IN} = 5 V, at normal operation	-	-	400	μA
Drain-source ON-resistance	R _{DS(ON)}	-	V _{IN} = 5 V, I _D = 1 A	-	-	0.25	Ω
Protective circuit operation input Voltage range	V _{IN(opr)}	-	-	3.5	-	6	V
Overtemperature detection (Note 6)	T _{OT}	2	V _{IN} = 5 V, V _{DD} = 12 V	125	-	-	°C
Overcurrent detection	I _{OC}	3	V _{IN} = 5 V, V _{DS} = 24 V	-	5	-	A
Switching times	t _{on}	4	V _{DD} = 24 V, V _{IN} = 0 V/5 V, R _L = 24 Ω	-	15	-	μs
	t _{off}			-	45	-	
Drain-source diode forward Voltage	V _{DSF}	-	V _{IN} = 0 V, I _{DR} = 1.5 A	-	0.9	1.8	V

Note 6: Overtemperature protection is tripped at a channel temperature of 125°C.

Ensure that the channel temperature, T_{ch}, does not exceed 125°C under the worst-case conditions.

This feature is intended to protect the device against damage. The device reliability is not guaranteed if the device persists to remain overtemperature protection mode.

Test Circuit 1

H-level input voltage, L-level input voltage measuring circuit

Test circuit

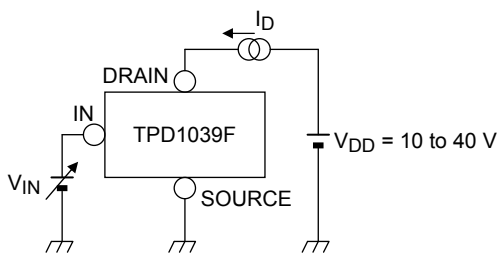

Measured waveforms

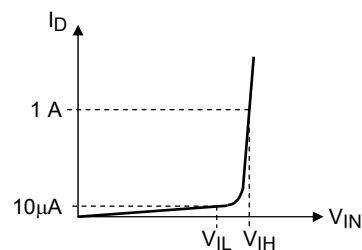

Test Circuit 2

Overtemperature detection measuring circuit

Test circuit

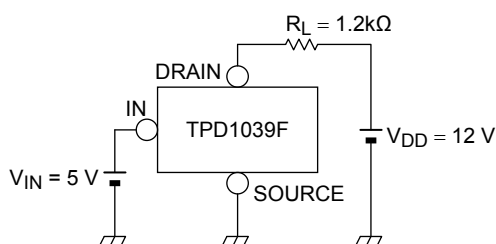

Measured waveforms

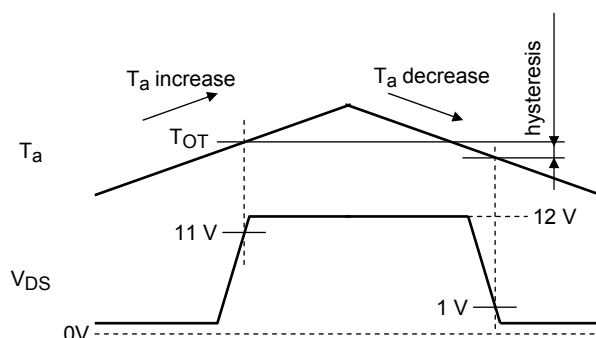

Test Circuit 3

Overcurrent detection circuit

Test circuit

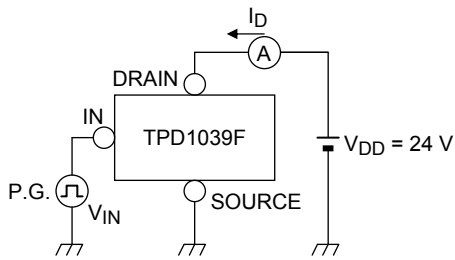

Measured waveforms

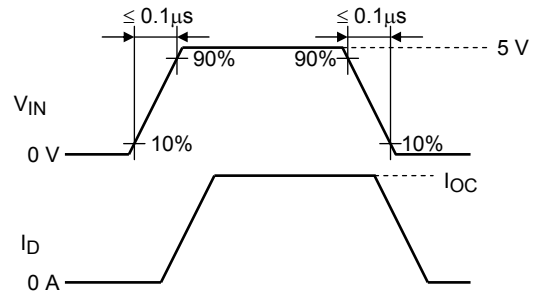

Test Circuit 4

Switching time measuring circuit

Test circuit

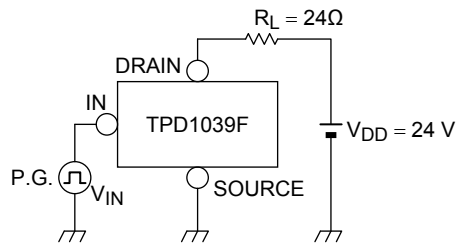

Measured waveforms

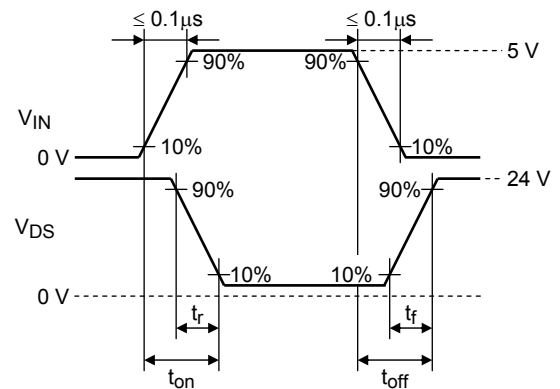

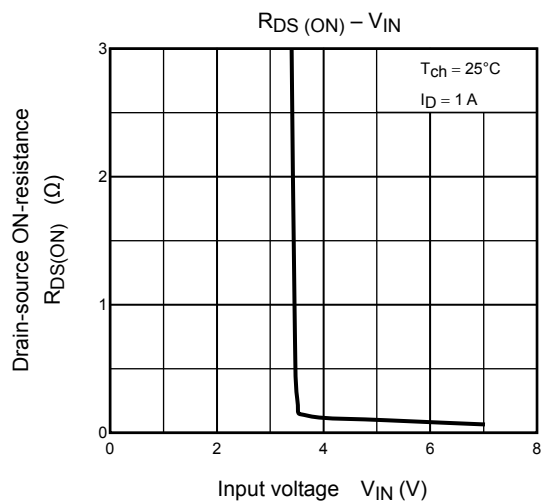
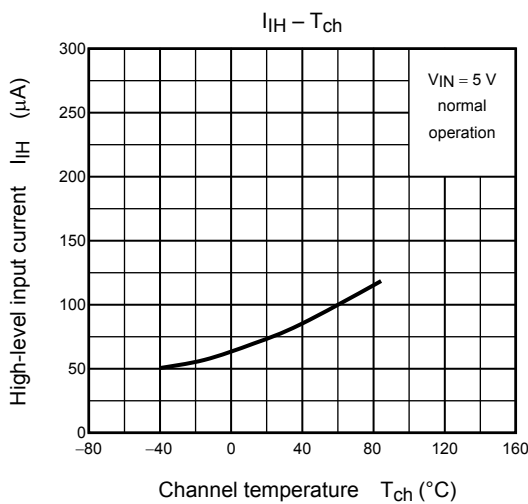
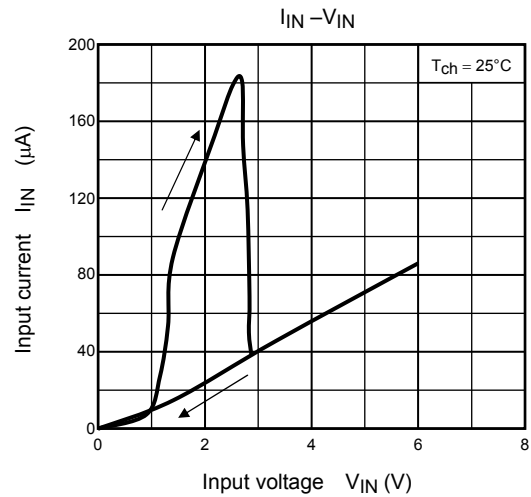
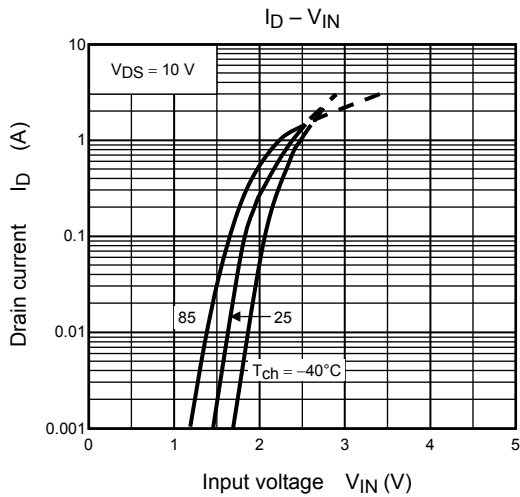
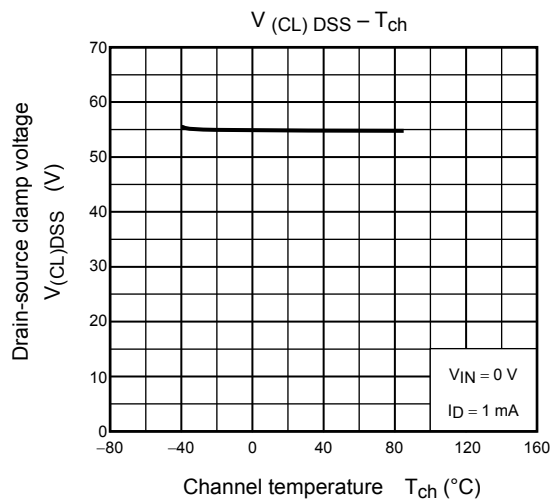
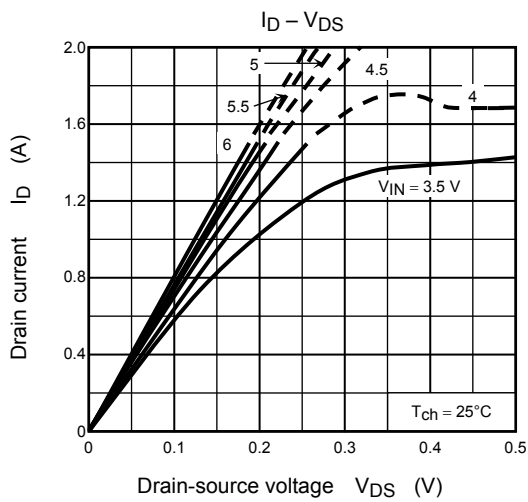

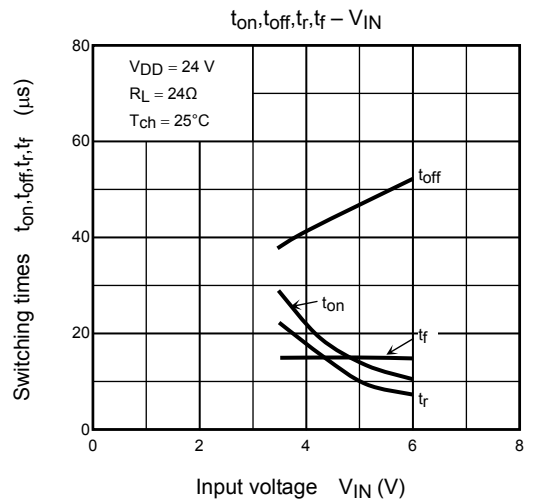
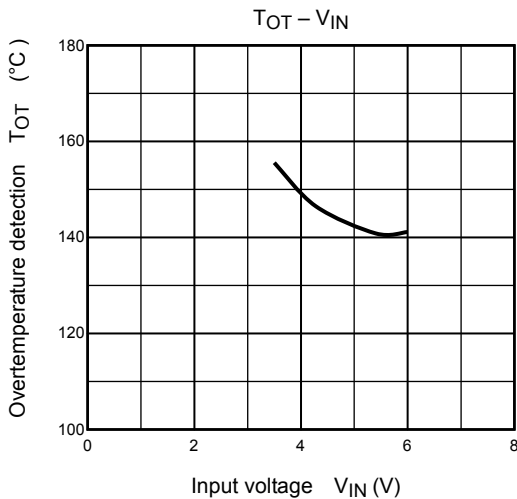
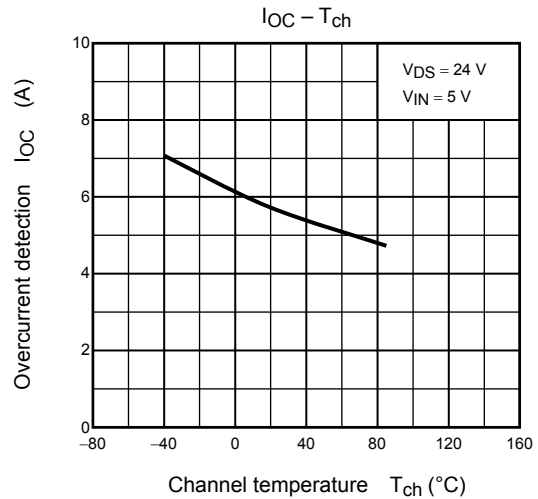
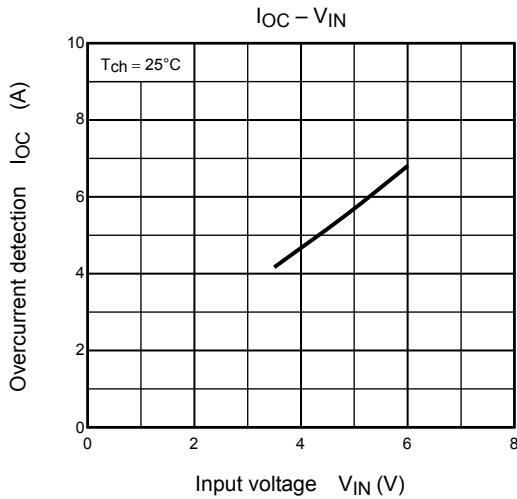
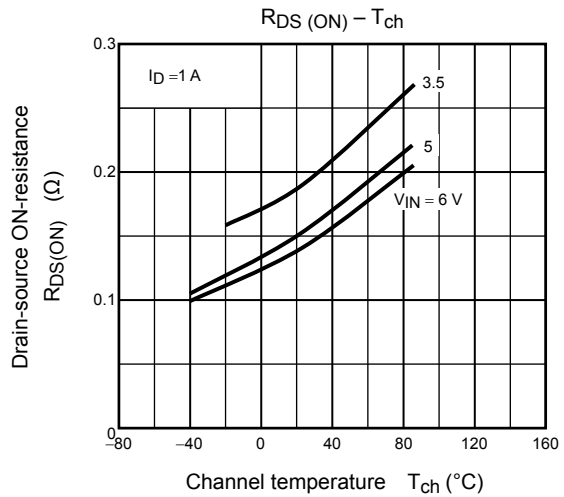
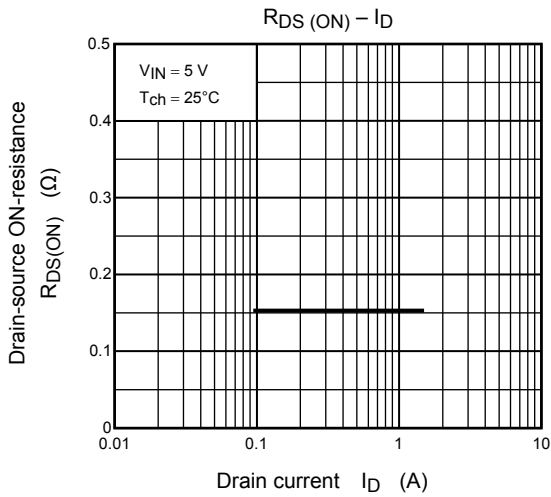

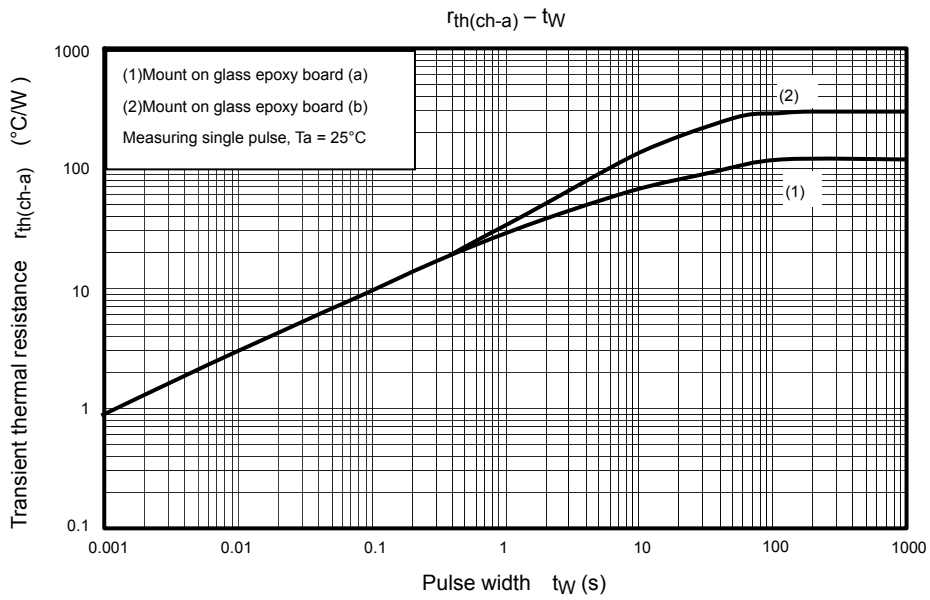
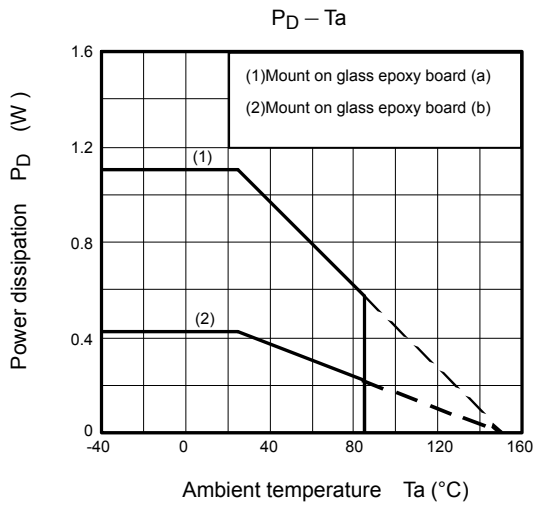

Package Dimensions

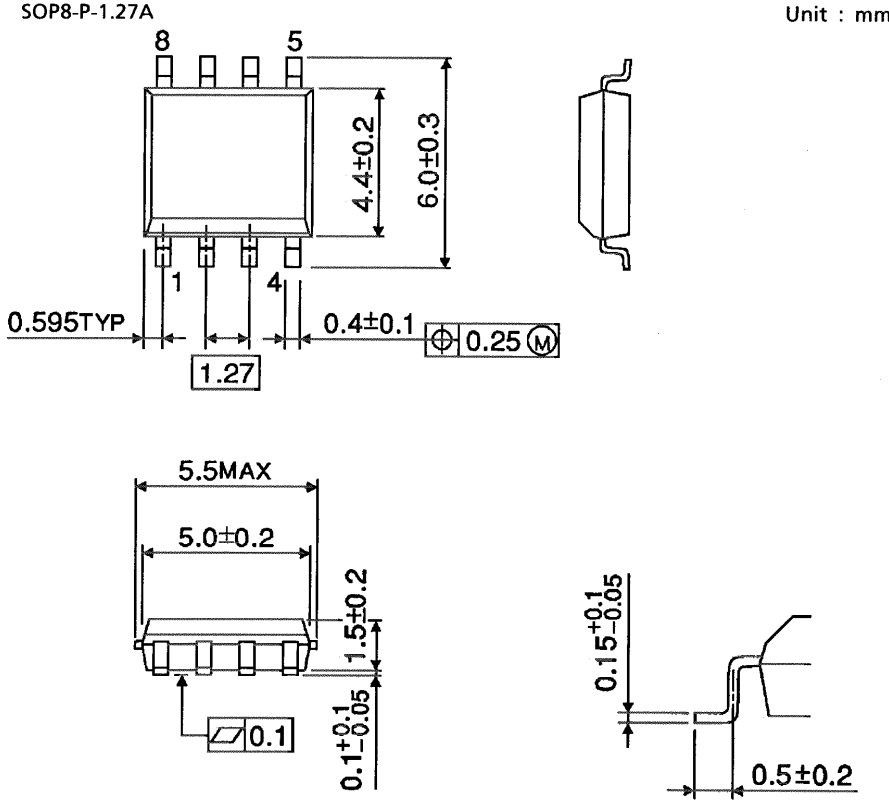

Weight: 0.08 g (typ.)

RESTRICTIONS ON PRODUCT USE

20070701-EN GENERAL

- The information contained herein is subject to change without notice.
- TOSHIBA is continually working to improve the quality and reliability of its products. Nevertheless, semiconductor devices in general can malfunction or fail due to their inherent electrical sensitivity and vulnerability to physical stress. It is the responsibility of the buyer, when utilizing TOSHIBA products, to comply with the standards of safety in making a safe design for the entire system, and to avoid situations in which a malfunction or failure of such TOSHIBA products could cause loss of human life, bodily injury or damage to property.
In developing your designs, please ensure that TOSHIBA products are used within specified operating ranges as set forth in the most recent TOSHIBA products specifications. Also, please keep in mind the precautions and conditions set forth in the "Handling Guide for Semiconductor Devices," or "TOSHIBA Semiconductor Reliability Handbook" etc.
- The TOSHIBA products listed in this document are intended for usage in general electronics applications (computer, personal equipment, office equipment, measuring equipment, industrial robotics, domestic appliances, etc.). These TOSHIBA products are neither intended nor warranted for usage in equipment that requires extraordinarily high quality and/or reliability or a malfunction or failure of which may cause loss of human life or bodily injury ("Unintended Usage"). Unintended Usage include atomic energy control instruments, airplane or spaceship instruments, transportation instruments, traffic signal instruments, combustion control instruments, medical instruments, all types of safety devices, etc.. Unintended Usage of TOSHIBA products listed in this document shall be made at the customer's own risk.
- The products described in this document shall not be used or embedded to any downstream products of which manufacture, use and/or sale are prohibited under any applicable laws and regulations.
- The information contained herein is presented only as a guide for the applications of our products. No responsibility is assumed by TOSHIBA for any infringements of patents or other rights of the third parties which may result from its use. No license is granted by implication or otherwise under any patents or other rights of TOSHIBA or the third parties.
- Please contact your sales representative for product-by-product details in this document regarding RoHS compatibility. Please use these products in this document in compliance with all applicable laws and regulations that regulate the inclusion or use of controlled substances. Toshiba assumes no liability for damage or losses occurring as a result of noncompliance with applicable laws and regulations.