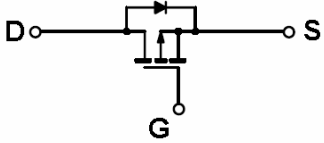

20V P-Channel Enhancement Mode MOSFET

<p>SOT-23</p>  <p>Pin assignment: 1. Gate 2. Source 3. Drain</p>	<p>V_{DS} = - 20V R_{DS} (on), V_{GS} @ - 4.5V, I_{DS} @ - 2.8A = 130mΩ R_{DS} (on), V_{GS} @ - 2.5V, I_{DS} @ - 2.0A = 190mΩ</p>								
<p>Features</p> <ul style="list-style-type: none"> ◇ Advanced trench process technology ◇ High density cell design for ultra low on-resistance 	<ul style="list-style-type: none"> ◇ Excellent thermal and electrical capabilities ◇ Compact and low profile SOT-23 package 								
<p>Block Diagram</p> 	<p>Ordering Information</p> <table border="1" data-bbox="849 996 1433 1081"> <thead> <tr> <th>Part No.</th> <th>Packing</th> <th>Package</th> </tr> </thead> <tbody> <tr> <td>RTM2301CX</td> <td>Tape & Reel</td> <td>SOT-23</td> </tr> </tbody> </table>			Part No.	Packing	Package	RTM2301CX	Tape & Reel	SOT-23
Part No.	Packing	Package							
RTM2301CX	Tape & Reel	SOT-23							
<p>Absolute Maximum Rating (Ta = 25 °C unless otherwise noted)</p>									
<p>Parameter</p>	<p>Symbol</p>	<p>Limit</p>	<p>Unit</p>						
<p>Drain-Source Voltage</p>	<p>V_{DS}</p>	<p>- 20V</p>	<p>V</p>						
<p>Gate-Source Voltage</p>	<p>V_{GS}</p>	<p>± 8</p>	<p>V</p>						
<p>Continuous Drain Current</p>	<p>I_D</p>	<p>- 2.3</p>	<p>A</p>						
<p>Pulsed Drain Current</p>	<p>I_{DM}</p>	<p>- 10</p>	<p>A</p>						
<p>Maximum Power Dissipation</p>	<p>Ta = 25 °C</p>	<p>1.25</p>	<p>W</p>						
	<p>Ta = 75 °C</p>	<p>0.8</p>							
<p>Operating Junction Temperature</p>	<p>T_J</p>	<p>+150</p>	<p>°C</p>						
<p>Operating Junction and Storage Temperature Range</p>	<p>T_J, T_{STG}</p>	<p>- 55 to +150</p>	<p>°C</p>						
<p>Thermal Performance</p>									
<p>Parameter</p>	<p>Symbol</p>	<p>Limit</p>	<p>Unit</p>						
<p>Lead Temperature (1/8" from case)</p>	<p>T_L</p>	<p>5</p>	<p>S</p>						
<p>Junction to Ambient Thermal Resistance (PCB mounted)</p>	<p>Rθja</p>	<p>100</p>	<p>°C/W</p>						

Note: Surface mounted on FR4 board t<=5sec.

Electrical Characteristics						
Ta = 25°C, unless otherwise noted						
Parameter	Conditions	Symbol	Min	Typ	Max	Unit
Static						
Drain-Source Breakdown Voltage	V _{GS} = 0V, I _D = -250uA	BV _{DSS}	-20	--	--	V
Drain-Source On-State Resistance	V _{GS} = -4.5V, I _D = -2.8A	R _{DS(ON)}	--	95	130	mΩ
Drain-Source On-State Resistance	V _{GS} = -2.5V, I _D = -2.0A	R _{DS(ON)}	--	122	190	
Gate Threshold Voltage	V _{DS} = V _{GS} , I _D = -250uA	V _{GS(TH)}	-0.45	--	--	V
Zero Gate Voltage Drain Current	V _{DS} = -16V, V _{GS} = 0V	I _{DSS}	--	--	-1.0	uA
Gate Body Leakage	V _{GS} = ±8V, V _{DS} = 0V	I _{GSS}	--	--	±100	nA
On-State Drain Current	V _{DS} ≥ -10V, V _{GS} = -5V	I _{D(ON)}	-6	--	--	A
Forward Transconductance	V _{DS} = -5V, I _D = -2.8A	g _{fs}	--	6.5	--	S
Dynamic						
Total Gate Charge	V _{DS} = -6V, I _D = -2.8A, V _{GS} = -4.5V	Q _g	--	5.4	10	nC
Gate-Source Charge		Q _{gs}	--	0.8	--	
Gate-Drain Charge		Q _{gd}	--	1.1	--	
Turn-On Delay Time	V _{DD} = -6V, R _L = 6Ω, I _D = -1A, V _{GEN} = -4.5V, R _G = 6Ω	t _{d(on)}	--	5	25	nS
Turn-On Rise Time		t _r	--	19	60	
Turn-Off Delay Time		t _{d(off)}	--	95	110	
Turn-Off Fall Time		t _f	--	65	80	
Input Capacitance	V _{DS} = -6V, V _{GS} = 0V, f = 1.0MHz	C _{iss}	--	447	--	pF
Output Capacitance		C _{oss}	--	127	--	
Reverse Transfer Capacitance		C _{rss}	--	80	--	
Source-Drain Diode						
Max. Diode Forward Current		I _S	--	--	-1.6	A
Diode Forward Voltage	I _S = -1.6A, V _{GS} = 0V	V _{SD}	--	-0.8	-1.2	V

Note : pulse test: pulse width ≤300uS, duty cycle ≤2%

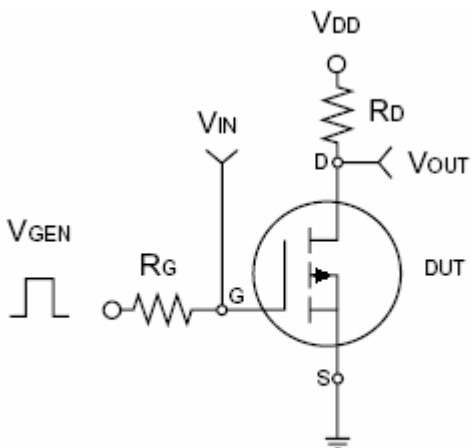

Switching Test Circuit

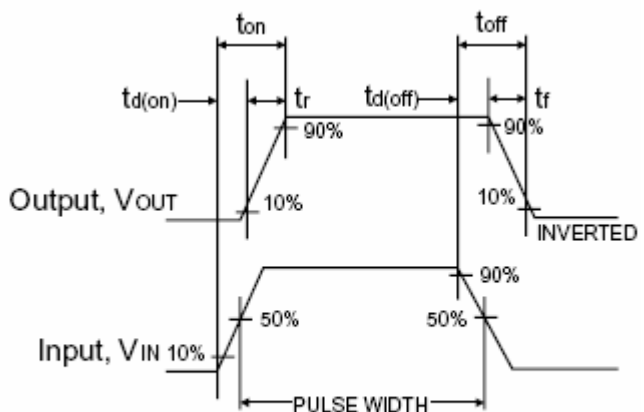

Switchin Waveforms

Typical Characteristics Curve (Ta = 25 °C unless otherwise noted)

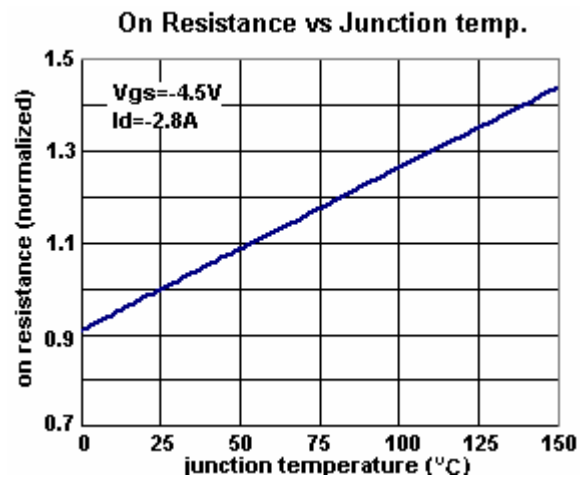
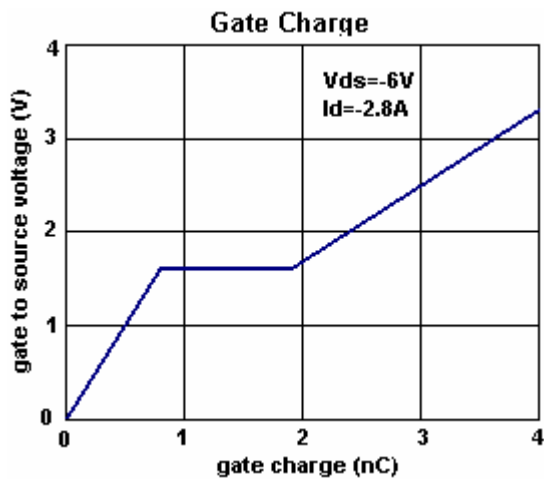
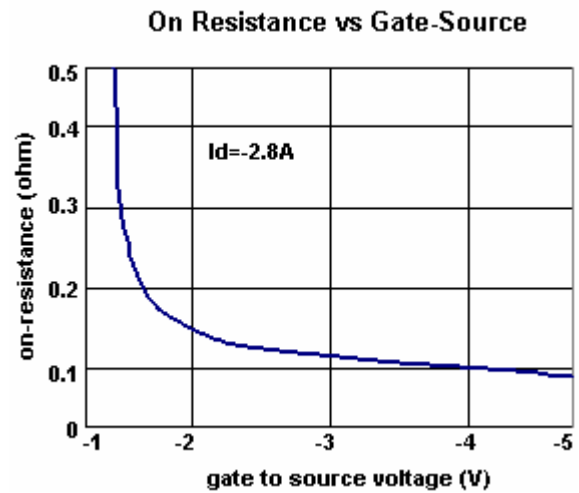
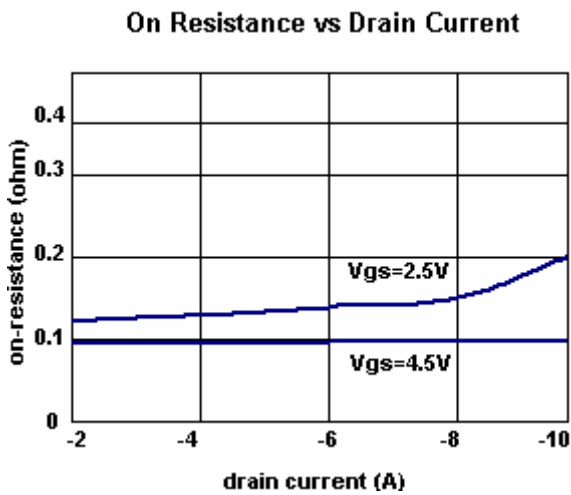
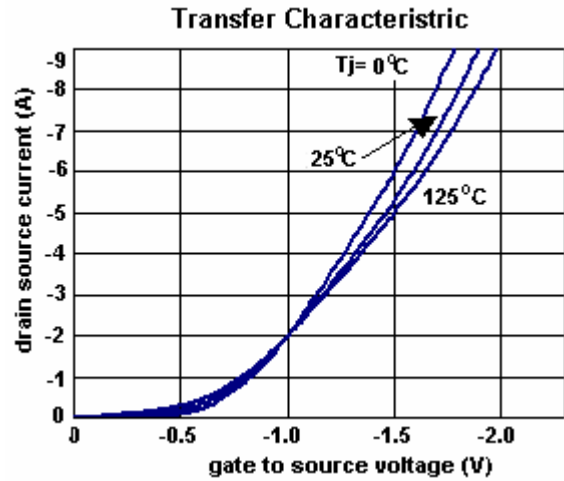
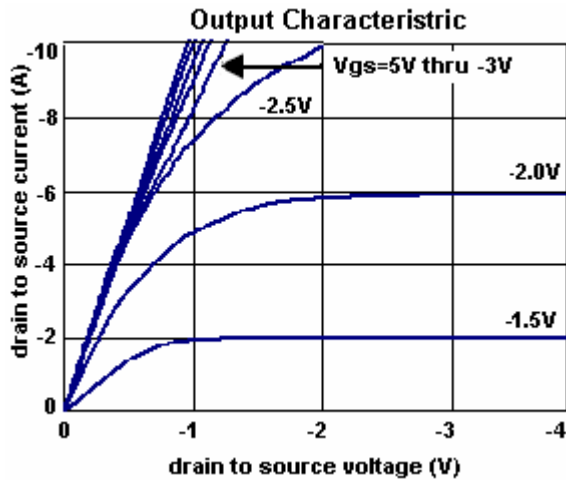

Typical Characteristics Curve ($T_a = 25^\circ\text{C}$ unless otherwise noted)

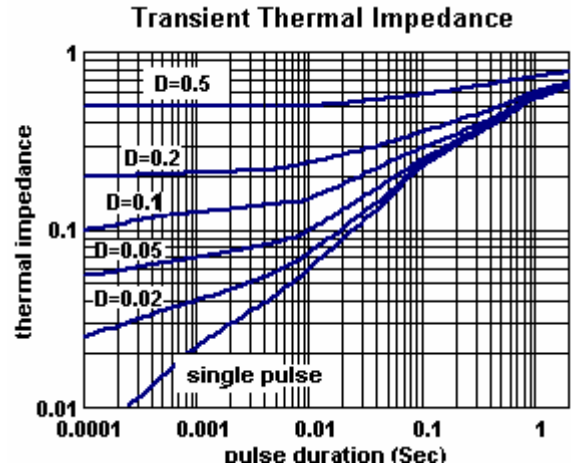
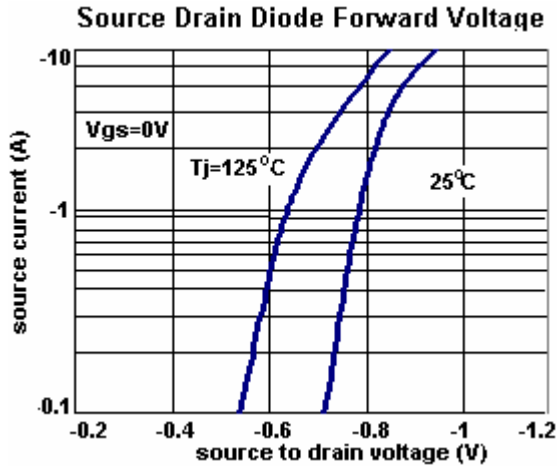

SOT-23 Mechanical Drawing

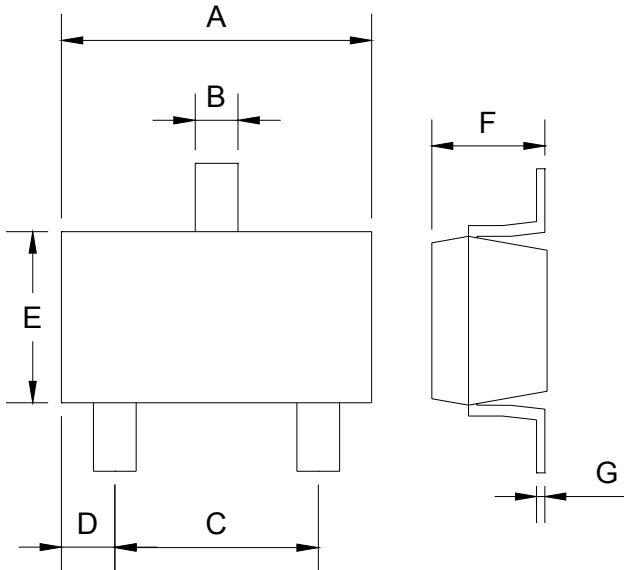

SOT-23 DIMENSION				
DIM	MILLIMETERS		INCHES	
	MIN	MAX	MIN	MAX
A	2.88	2.91	0.113	0.115
B	0.39	0.42	0.015	0.017
C	1.78	2.03	0.070	0.080
D	0.51	0.61	0.020	0.024
E	1.59	1.66	0.063	0.065
F	1.04	1.08	0.041	0.043
G	0.07	0.09	0.003	0.004